

Compact Air Handling Units

Compact Air Handling Units

from 3000 to 20000 m³/h

AIRME

H₂O

R32
REFRIGERANT



AIRME



Nowadays we spend most of our time in indoor environments. The fresh air treatment is the key to achieving better comfort. AIRME is the new Mitsubishi Electric compact and pre-configured Air Handling Units from 3000 to 20000 m³/h **for complete air conditioning of small/medium volume environment (cooling, heating, humidification and dehumidification) with air renewal up to 100%.**

THE SERIES

Partial or full fresh air AHUs
7 sizes in 3 versions: Basic (C), Intermediate (I) and Boosted (B)
Hydronic or Direct expansion

WIDE CAPACITY RANGE



AIRME AR All Recirculation

Airflow from 3000 to 20000 m³/h
Cooling capacity from 10 to 125 kW



AIRME MF Mixing & Free Cooling

Airflow from 3000 to 20000 m³/h
Cooling capacity from 10 to 125 kW



AIRME HR/P Plate heat exchanger

Airflow from 3000 to 15000 m³/h
Cooling capacity from 20 to 150 kW

PERFECT INTEGRATION WITH MITSUBISHI SYSTEMS

The range is equipped with an air treatment hydronic or direct expansion coil, optimized to work in synergy with Mitsubishi Electric units such as MECH/MEHP-iS or Mr Slim.





Groundbreaking performance

AIRME brings brilliant performance, operating **down to -20°C** in heat pump mode.

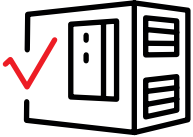

Standardized and pre-configured range

The concept of the new air handling unit AIRME is based on targeted design and the use of standard components, which allows optimization of each production step and assures high quality level and reliability.



Air quality

Thanks to a complete range of filters and technologies (**electronic filters, PCO lamps and CO₂ probe**) AIRME is the cutting-edge solution for air sanitization.

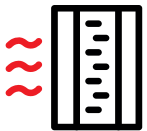

Improved casing performance

The insulation of the unit is significantly **improved thanks to** the new structure based on self supporting panels **which drastically improve the thermal bridging effects compared to classic structures with aluminium profiles.**



Complete Plug&Play solution

The AIRME units are fully Plug&Play solutions equipped with an advanced and proprietary controller developed by MEHITS S.p.a. Able to manage both ventilation and heating/cooling demands, the controller exploits at best the energy coming from the coupled Mitsubishi Electric units.



Quick selection and quotation

Thanks to standardized design, the new AIRME can be easily selected within APPLY ME in a few simple steps, always keeping high versatility of capacity and high configurability.

AIRME: fully dedicated to comfort

Complete solution for:

- ✓ COOLING
- ✓ HEATING
- ✓ AIR FILTRATION
- ✓ HUMIDIFICATION and DEHUMIDIFICATION
- ✓ AIR RENEWAL

- Industrial buildings
- Warehouses
- Supermarket and retail
- Cinemas and theatres
- Conference rooms



Why R32?



AIRME with R32 refrigerant is key in the company's path towards the creation of a greener future.

The reduced GWP level of this refrigerant gas tackles both direct and indirect global warming, offering customers a concrete forward-looking solution for your building and a concrete alternative to traditional refrigerants.

R32
REFRIGERANT



Low GWP

-66% GWP vs R410A



Safety Class A2L



Reduced Environmental Impact

- **ODP** - Ozone Depletion Potential
- One-third GWP compared to R410A
- F-Gas phasedown compliant



Performance & Envelope

- Ideal for the next generation of equipment
- Requires less refrigerant volume per kW
- High refrigeration and thermal conductivity
- Low pressure drops
- Affordable and readily available



Reliability

- Easy to handle, reuse, and recycle
- Low toxicity, low flammability
- A single component refrigerant

Technological Choices

AIRME AR and MF

Control panel

Built-in control panel with integrated ventilation system always provided onboard, to ensure the maximum safety against overheating, refrigerant gas stagnation, condensation on electrical component. Thanks to AIR 3000 +, the control software fully developed by MEHITS, and the combination with PAC IF cards, the management of both the ventilation and the cooling/heating demand are optimized.

Filters

Prefilters + rigid bag filters with side withdrawal for gross and fine filtration.

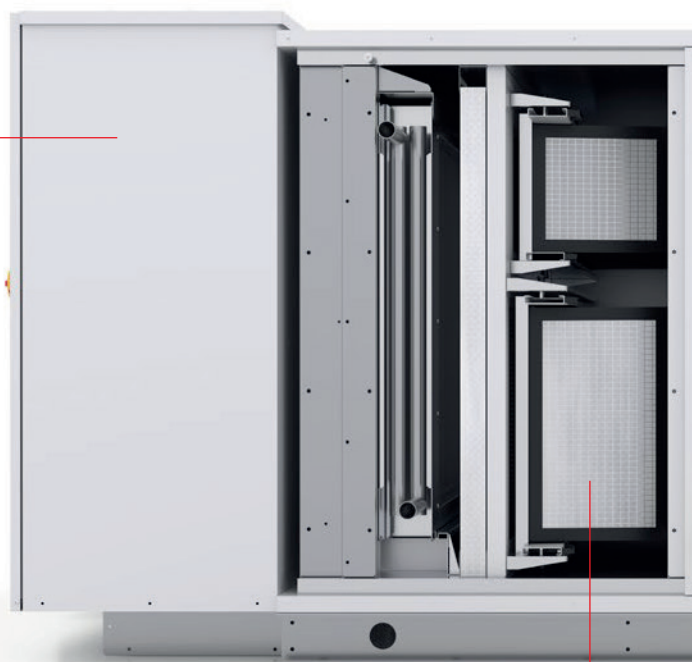

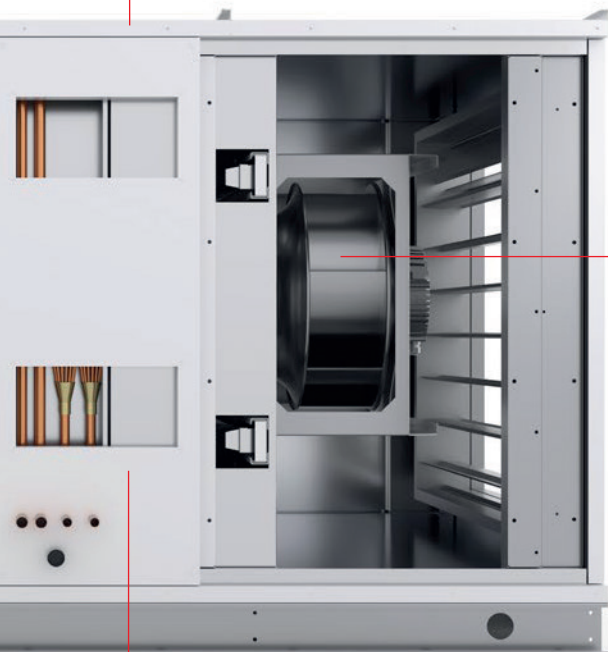

Structure

Self-supporting structure with sandwich panels:

- Panel thickness 60mm;
- Polyurethane insulation as standard to guarantee **high thermal insulation**;
- Smooth RAL7035 pre-painted external panels;
- Galvanized steel internal panels.

EC Plug fans

Supply and return (according to the configuration) plug fans with brushless EC motors, to ensure the best efficiencies and highest energy savings. They manage constant airflow or constant pressure controls, as well as the variable airflow operation.

Air treatment coil

Air treatment coil, hydronic or direct expansion, from 10 to 125 kW, designed according to the Mitsubishi Electric standards:

- **w-AIRME:** water air treatment coil optimized to work with Mitsubishi Electric chillers or heat pumps.
- **s-AIRME-G07:** direct expansion coil optimized to work with R32 Mr Slim outdoor units.

Technological Choices

AIRME HR/P

Control panel

Built-in control panel with integrated ventilation system always provided onboard, to ensure the maximum safety against overheating, refrigerant gas stagnation, condensation on electrical component. Thanks to AIR 3000 +, the control software fully developed by MEHITS, and the combination with PAC IF cards, the management of both the ventilation and the cooling/heating demand are optimized.

EC Plug fans

Supply and return (according to the configuration) plug fans with brushless EC motors, to ensure the best efficiencies and highest energy savings. They manage constant airflow or constant pressure controls, as well as the variable airflow operation.

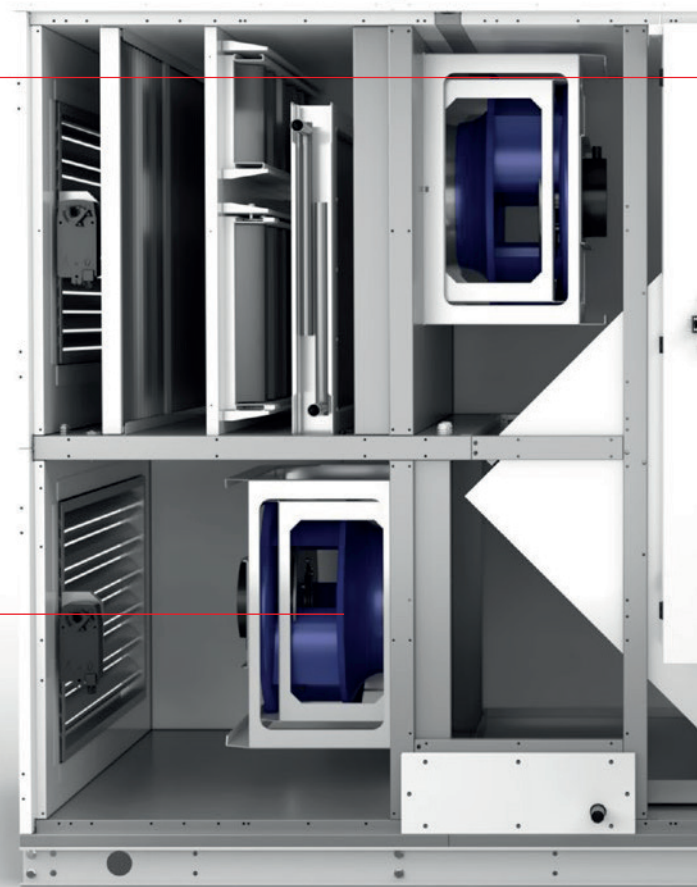
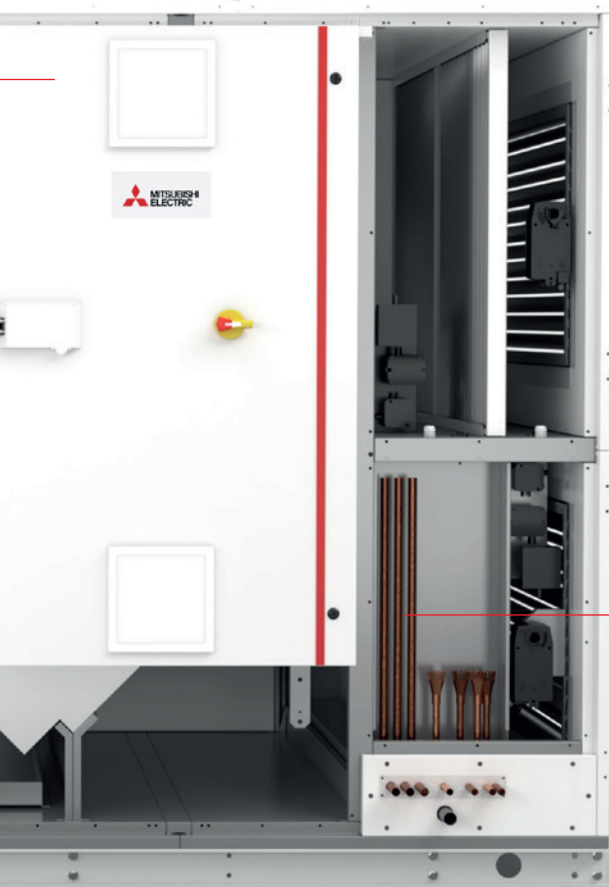

Plate heat recovery

High efficiency plate heat exchanger for energy recovery between the fresh and the return air. The system has been designed to avoid high pressure drops and satisfy the ErP efficiency limits. Complete separation between supply and return air flows, with no risk of contamination.



Air treatment coil

Air treatment coil, hydronic or direct expansion, from 20 to 150 kW, designed according to the Mitsubishi Electric standards:

w-AIRME: water air treatment coil optimized to work with Mitsubishi Electric chillers or heat pumps.

s-AIRME-G07: direct expansion coil optimized to work with R32 Mr Slim outdoor units.

Flow Management

SINGLE FLOW MANAGEMENT

AR All Recirculation | 100% Recirculated air

→ Return air flow
→ Supply air flow

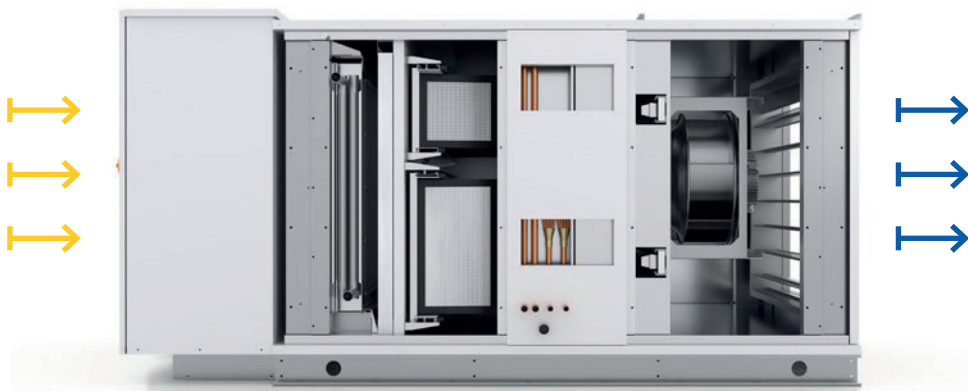

MF Mixing and Free cooling | Partial and full fresh air, Free cooling

→ Return air flow
→ Supply air flow
→ Fresh air flow

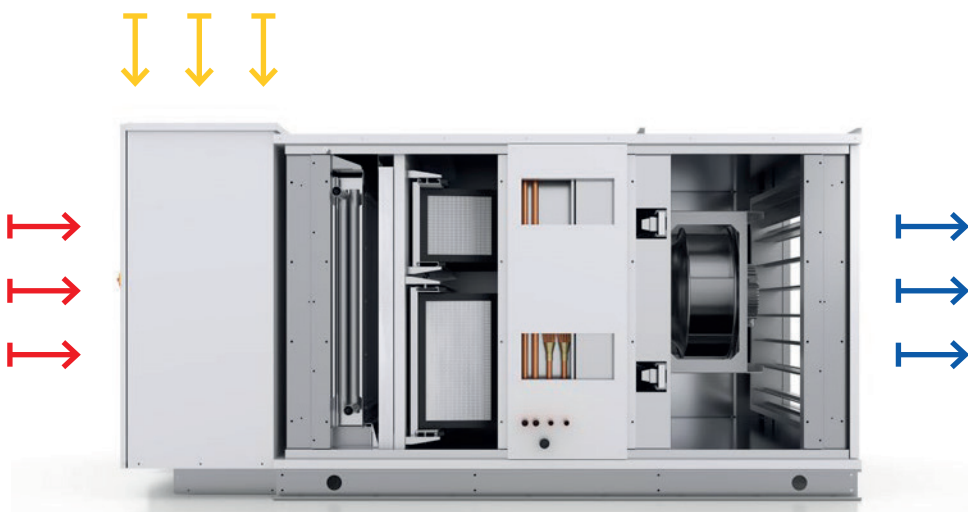

DOUBLE FLOWS MANAGEMENT

HR-P Heat Recovery – Plate heat ex. | Full fresh air, Free cooling

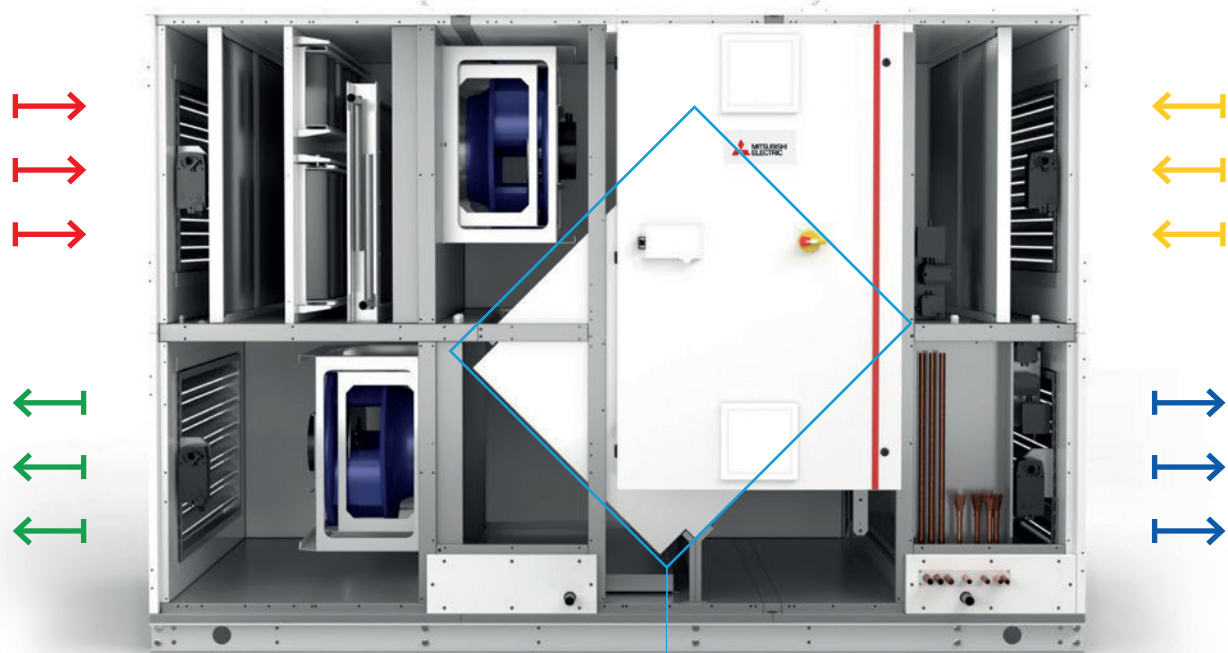

- Return air flow
- Supply air flow
- Fresh air flow
- Exhaust air flow



Plate Heat Exchanger

Accessories

We supply high quality accessories

The main objective is to ensure high levels of customer satisfaction. Continuous upgrade of the units' performance and the use of quality accessories can contribute in extending the life cycle of the plant.



Air quality control in the environment with CO₂ probe



Pre-heating and re-heating electric or hot water coils

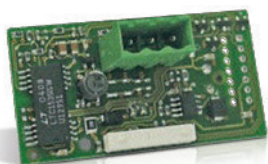

BMS system connections

THE NEW AIRME RANGE HAS BEEN DESIGNED WITH EXCELLENCE TO SATISFY THE SYSTEM AND TECHNOLOGY REQUIREMENTS OF MODERN BUILDINGS

The main objective is to meet every customer needs, a wide range of accessories makes the new unit the perfect solution for any installation requirements.

- **2- or 3-way mixing box for air recirculation**
- **Roof**
Aluminum roof for outdoor installations
- **Steam humidifier section**
Additional section equipped with with immersed electrodes which produces steam to control the humidity level of the rooms.
- **Dampers for fresh air intake, supply, return and exhaust airflows**
- **Supply and return safety dampers**
(for s-AIRME-G07 only)
A unique solution for a complete environmental safety, even for areas with open flames (kitchens, smoking rooms, etc) or in case of blackouts.
- **High pressure fans**
Uprated fans available for both supply and return

Solutions for perfect Air Sanitization

Active Sanitization System with Photocatalytic Oxidation



The active sanitizing system features a special UV-C lamp which uses the Photocatalytic oxidation process to reduce the microbial load airborne (such as bacteria,

molds, allergens, odors, organic and volatile compounds, ultra-fine powders), in order to make your environment a healthier living place.

SUPERMARKETS AND FOOD CHAINS

It has been proven that the use of this technology not only increases air quality, but also increases the duration of food freshness because the bacteriological load in the air is reduced.

HOTELS, GYMS & RESTAURANTS

Reduction of smells and contaminants, giving the perception of healthier air in the rooms.

OFFICE BUILDINGS

Reduction of bacteria, allergens, and odors which can cause allergies or respiratory diseases.

MAIN FEATURES



Healthier and cleaner air

Ionization process for capturing and breaking down molecules of toxic VOCs, which can cause allergic phenomena or respiratory tract diseases.



Odour reduction

Smoke, chemicals, kitchen fumes, etc.



Reduced maintenance

Quick and easy cleaning of the honeycomb structure with a simple jet of compressed air.



Reduction of the bacterial load

Reduction of the bacterial load and germs present in the air up to 95-99%.



ELECTRONIC FILTERS

Electronic filters based on the electrostatic precipitation process are used to purify the air in the rooms. Their working principle involves using electricity to catch dust, pollen, and other airborne particles prior to them entering your building.

Operating principle

The dirty air passes through the layer of ionizers, which emit charged ions. These charged ions attract the dirt solid particles contained in the air which are then captured from the collection plate. The extra electrostatic charged particles drive the dirty particles towards the collector, allowing clean fresh air to enter your home.

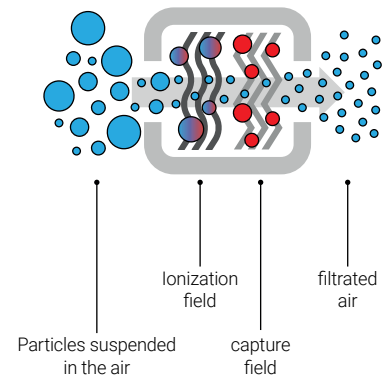

Measurement of the bacterian load in the air before and after the electrostatic filter.

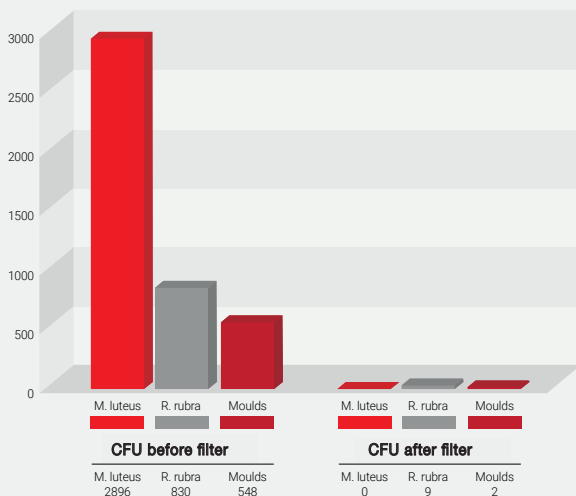

Single-pass effect of Electrostatic filter

The concentration of the bacteria commonly present in a given environmental air have been measured before and after the electrostatic filters.

The efficiency of bacteria removal is 98-99% for:

- Airborne bacteria, such as *Micrococcus luteus*;
- Yeast, such as *Rhodotorula rubra*;
- *Bacillus Anthracis*;
- Molds and germs present in the natural spectrum of air

AIR 3000+

The Control Software fully developed by MEHITS to manage all available functions

- + **Available resources management**
according to ambient temperature with proportional or proportional + integral logic.
- + Automatic management of free cooling, based on temperature or enthalpy.
- + **Fans management**
 - **Variable airflow** management
 - Fixed speed management
 - Constant pressure management
- Summer and winter **humidity control**
(dehumidification, re-heating, humidification)
- **HPTC high-pressure temperature control**
Automatic control of fresh air damper and, if necessary, reduction of circuit load to prevent shut down due to extremely high external temperature
- **Set point compensation**
Reduction of temperature difference: $T_{AMB} - T_{EXT}$
Discomfort reduction and avoidance of out-of-limit operations.
- Built-in clock with daily **scheduling** function.
- **BMS** interfacing.

IMOUC MITSUBISHI PROTOCOL (s-AIRME-G07 only)

Intelligent Multiple Outdoor Units Control

- > **Unique** controller for ventilation and air conditioning function
- > **Capacity control**
from 20% to 100%
- > **Balanced defrost** to avoid simultaneous defrosting
- > Priority to Mr Slim OU with **higher efficiency**
- > **Rotation** control to make cumulative operation time of each Mr Slim
- > **Back-up operation**, in case of one Mr Slim failure, next one starts to operate automatically
- > **Temperature set point** with acceptable deviation to reduce the ON/OFF cycling of Mr Slim
- > **Night purge** function to reduce the air temperature inside the building using only the fresh air

AIR 3000+ Touch

The touch screen room thermostat



Air3000touch+ is the new user interface dedicated to the smart control of your ventilation and air conditioning system.

Designed to provide customers with the most easy and intuitive control experience, Air 3000 touch + reports all functions and settings of the unit:

READY-TO-INSTALL TOUCH SCREEN

The smart thermostat can be easily installed in public spaces without any risk in terms of safety. Access to the menu is in fact protected by a password.

EASY AND INTUITIVE

Coloured touch screen with user-friendly icons to ensure the easiest possible use.

AUTONOMOUS CONTROL

Incorporated Temperature and Humidity probes detect the room requirements, automatically adjusting the control settings, with minimal intervention on the user side.

■ KIPlink: the Keyboard in your Pocket

An exclusive product of Mitsubishi Electric Hydronics & IT Cooling Systems

Based on Wi-Fi technology, KIPlink is an option that allows one to operate on the unit directly from a mobile device (smartphone, tablet, or notebook) by simply scanning the QR code positioned on the unit.

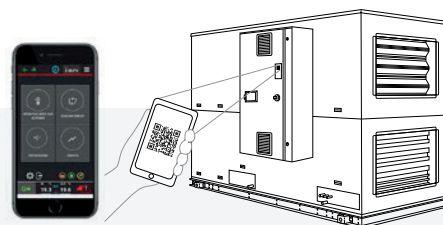

Suitable for industrial environment

tolerates temperatures from -20 to +65°C

Wi-Fi communication

no internet connection needed



Easier on-site operation

- Monitor each component while moving around the unit for maintenance.
- View and change all parameters with easy-to-understand screenshots and dedicated tooltips.
- Get devoted "help" messages for alarm reset and trouble shooting.



Real-time graphs and trends

- Monitor the real time status of the compressors, heat exchangers, cooling circuits, air dampers, CO2 probes, etc...
- View the real-time graphs of the key operating variable trends.



Data logger function

- Logging of events is automatic, and consultation of the history is facilitated by filters and search functions. To simplify diagnostic operations, all operating data are stored 10 minutes before and after each alarm.
- All data are available for download.



Ready to use

- Download and install MEHITS APP
- Create and register your profile
- Scan the QR code and connect to the unit

LAN MANAGEMENT

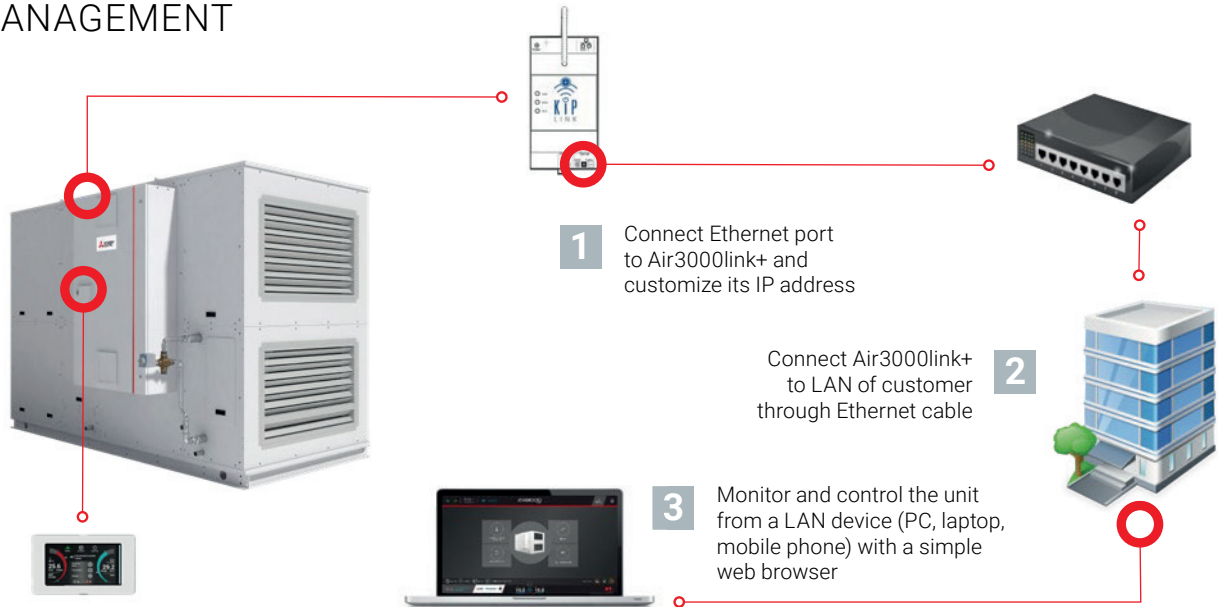

KIPLAN NETWORK

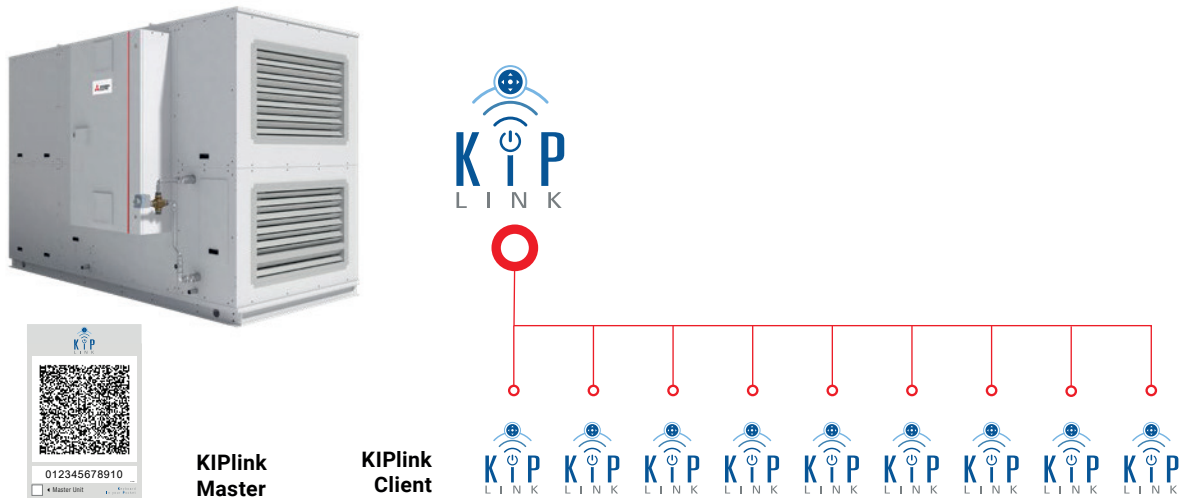

**MITSUBISHI ELECTRIC
HYDRONICS & IT COOLING SYSTEMS S.p.A.**

Head Office:

Via Caduti di Cefalonia 1 - 36061 Bassano del Grappa (VI) - Italy
Tel (+39) 0424 509 500 - Fax (+39) 0424 509 509

www.melcohit.com