

## Data Book

DB\_ME\_x-MEXT-i-G02-DX\_102022\_EN\_rev02

# x-MEXT-i-DX x-MEXT-i-DX DF

FULL INVERTER direct expansion air conditioners for IT Cooling.



The picture of the unit is indicative and may vary depending on the model

- PERIMETER INSTALLATION
- FULLY HERMETIC BLDC INVERTER COMPRESSORS
- SINGLE OR DOUBLE REFRIGERANT CIRCUIT
- AIR DELIVERY FROM THE BOTTOM OR FROM THE TOP
- PLUG FANS WITH EC ELECTRIC MOTOR
- ELECTRONIC EXPANSION VALVE
- AIR SUCTION UP TO 40°C



**Mitsubishi Electric Europe B.V.**  
Italian Branch

Campus, Energy Park  
Via Energy Park 14,  
20871 Vimercate (MB)

|   |    |
|---|----|
| CERTIFICATIONS .....  | 4  |
| GENERAL CHARACTERISTICS .....                               | 5  |
| INSTALLATION .....  | 7  |
| PRODUCT FEATURES AND BENEFITS .....                         | 8  |
| F-GAS DIRECTIVE .....                                       | 8  |
| IDENTIFICATION.....   | 8  |
| STORAGE AND SHIPMENT TEMPERATURE .....                      | 8  |
| OPERATION LIMITS .....                                      | 9  |
| THE SERIES.....   | 10 |
| COMPONENTS OF THE UNIT .....                                | 11 |
| MAIN COMPONENTS .....                                       | 11 |
| REMOTE CONDENSER.....                                       | 13 |
| STANDARD EQUIPMENT .....                                    | 14 |
| TECHNICAL DATA .....  | 15 |
| REFRIGERANT CHARGE .....                                    | 16 |
| DUAL FLUID SYSTEM .....                                     | 18 |
| WATER QUALITY OF THE HYDRAULIC CIRCUITS .....               | 18 |
| ANTIFREEZE MIXTURES .....                                   | 20 |
| REFRIGERANT SCHEME .....                                    | 21 |
| ACUSTIC DATA.....   | 22 |
| ELETRIC DATA .....  | 27 |
| MICROPROCESSOR CONTROL SYSTEM .....                         | 28 |
| ACCESSORIES .....   | 29 |
| ACCESSORY: B263 – OVER AIR INTAKE – BOTTOM SUPPLY .....     | 33 |
| ACCESSORY: B266 – FRONT AIR DELIVERY – TOP INTAKE .....     | 35 |
| ACCESSORY: B680 – CLOSING BASEMENT .....                    | 35 |
| ACCESSORY: B691 - KIT LOW TEMPERATURE .....                 | 35 |
| ACCESSORY: B692 - KIT LT+ ADDICTIONAL RECEIVER .....        | 35 |
| ACCESSORY: 601 – LIQUID LINE SOLENOID VALVE .....           | 35 |
| ACCESSORY: A547 – COSTANT AIR FLOW.....                     | 36 |
| ACCESSORY: A548 – CONSTANT PRELEVANCE .....                 | 36 |
| ACCESSORY: B951 - SINGLE-PHASE CONDENSER POWER SUPPLY ..... | 36 |
| ACCESSORY: B952 - THREE-PHASE CONDENSER POWER SUPPLY .....  | 36 |
| ACCESSORY: B793 – POWER SUPPLY 400/3+N/50 .....             | 36 |
| ACCESSORY 383 – NUMBERED WIRINGS + UK REQUESTS.....         | 36 |
| ACCESSORY: A842 – WITH NETWORK ANALYZER.....                | 36 |

ACCESSORY: P113 – KIT DUAL POWER SUPPLY ..... 37

ACCESSORY: 4180 – WITOUT SERIAL CARD..... 37

ACCESSORY: 4181 – SERIAL CARD MODBUS ..... 38

ACCESSORY: 4182 – SERIAL CARD LON ..... 38

ACCESSORY: 4184 – SERIAL CARD BACNET MS/TP RS485 ..... 38

ACCESSORY: 4185 – SERIAL CARD BACNET OVER IP..... 38

ACCESSORY: 6461 - HPC (ONLY DUAL FLUID VERSION)..... 38

ACCESSORY: 1441 - KIPLINK + COMPACT KEYBOARD ..... 39

ACCESSORY: 1442 - KIPLINK + 7 INCH TOUCH SCREEN ..... 41

ACCESSORY: 6192 - COMPACT KEYBOARD..... 41

ACCESSORY: 6196 – KIPLINK..... 41

ACCESSORY: 6195 - COMPACT 7 INCH TOUCH SCREEN ..... 41

ACCESSORY: C9261063 – REMOTE DISPLAY..... 42

ACCESSORY: P151 – LOWERED DISPLAY PER UNDER ..... 43

ACCESSORY: A492 - LEAKEAGE DETECTOR + ADDITIONAL RECEIVER..... 43

ACCESSORY: A501 – CLOGGED FILTER SENSOR ..... 43

ACCESSORY: A511 - SMOKE SENSOR ..... 43

ACCESSORY: A521– FIRE SENSOR ..... 43

ACCESSORY: B811 – AIR FLOW SENSOR..... 44

ACCESSORY: 4503 - FAST RESTART (ULTRACAP) ..... 44

ACCESSORY: 2412 - CONTROL PHASE SEQUENCE + CONTROL TENSION ..... 44

ACCESSORY: A381 – KIT CONDENSATE DRAIN PUMP ..... 44

ACCESSORY: A812 – WHIT DIRECT FREE COOLING..... 45

ACCESSORY: A791 – AIR TEMPERATURE CONTROL ON SUCTION AIR ..... 45

ACCESSORY: B803 - 3 WAY VALVE (ONLY DUAL FLUID VERSION) ..... 45

ACCESSORY: B807 - 2-WAY VALVE EPIV ..... 46

ACCESSORY: P201 – 2-WAY VALVE ..... 47

ACCESSORY: A431 – ELECTRIC HEATERS..... 47

ACCESSORY: P051- DEUMIDIFICATION FUNCTION..... 48

ACCESSORY: 4303 - HUMIDIFIER VAP. 8 KG/H UM08 ..... 48

ACCESSORY: 4305 - HUMIDIFIER VAP. 15 KG/H UM15 ..... 48

ACCESSORY: P161 - T/RH PROBE AIR SUCTION ..... 48

ACCESSORY: P071 - T/RH REMOTE PROBE (1 PROBE) ..... 49

ACCESSORY: P072 - T/RH REMOTE PROBE (2 PROBES)..... 50

ACCESSORY: P073 - T/RH REMOTE PROBE (3 PROBES)..... 50

|   |    |
|---|----|
| ACCESSORY: P074 - T/RH REMOTE PROBE (4 PROBES).....               | 50 |
| ACCESSORY: P080 – WITHOUT AIR FILTER .....                        | 50 |
| ACCESSORY: P084 - EPM10 50% AIR FILTER .....                      | 50 |
| ACCESSORY: P101 – KIT ANTI-SEISMIC ANCHOR .....                   | 50 |
| ACCESSORY: PLENUM.....  | 51 |
| OPTIONAL ACCESSORY: A531 - DAMPER ON-OFF .....                    | 52 |
| OPTIONAL ACCESSORY: B981 - SUPPORTING FRAME H 350 – 500 MM .....  | 58 |
| OPTIONAL ACCESSORY: B982 - SUPPORTING FRAME H 500 - 750 MM .....  | 59 |
| OPTIONAL ACCESSORY: B983 - SUPPORTING FRAME H 750 - 1000 MM ..... | 59 |
| OPTIONAL ACCESSORY: B991 – INSULATION.....                        | 59 |
| UNIT DRAWING .....  | 60 |
| OVERHEAD FLOOR DRILLING FOR MACHINES UNDER .....                  | 61 |
| EXAMPLES OF MACHINE NOISE CALCULATION .....                       | 67 |
| AIR FILTER EXTRACTION.....  | 69 |
| SHIPMENT: DIMENSIONS.....   | 71 |
| SHIPMENT: WEIGHT .....  | 72 |
| ACCESSORY PACKAGING DIMENSIONS AND SHIPMENT WEIGHTS .....         | 72 |

**Liability disclaimer**

This publication has been prepared for information purposes only and does not constitute a binding offer by Mitsubishi Electric. Mitsubishi Electric has compiled the contents of this publication to the best of its knowledge. The information contained in this publication is subject to change without notice. Mitsubishi Electric expressly disclaims any liability for any direct or indirect damage, in the broadest sense, arising out of or in connection with the use and/or interpretation of this publication. All contents are copyrighted by Mitsubishi Electric.



## ISO 9001 CERTIFICATION Quality Management System



## ISO 14001 CERTIFICATION Environmental Management System



## BS OHSAS 18001 CERTIFICATION Occupational Health and Safety Management System

### PRODUCT CERTIFICATIONS BY COUNTRY



CE MARKING

## INTRODUCTION

The direct expansion perimeter unit has been designed following a path aimed at satisfying specific requirements such as ease of installation, total front accessibility, and especially performance. These results were made possible by MEHITS' experience of more than 50 years in the field of IT Cooling.

This solution is ideal for cooling IT equipment with small to medium thermal loads (< 1000 kW), typically Enterprise, Edge and Colocation Datacenters but also battery rooms and UPSs. The entire range offers a wealth of configuration possibilities thanks to the large number of ACCESSORIES and versions available.

The available versions are shown here. For ease of reference, 2 Databooks have been created comprising two groups

### DX / DX DF

Direct Expansion - DX

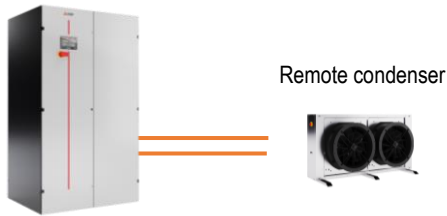

Dual Fluid – DX DF

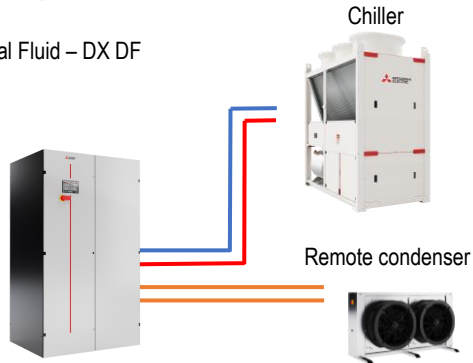

### DW / DW FC / DW DF

Direct Expansion, water cooled - DW

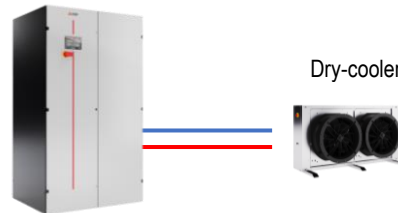

Direct Expansion, water cooled + FC coil – DW FC



Dual Fluid – DW DF

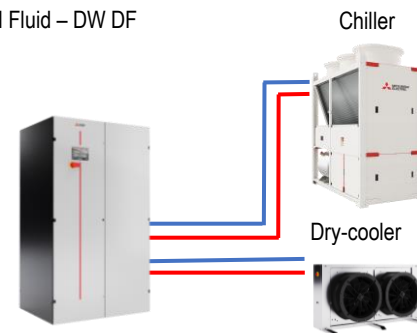

## FULL INVERTER Air conditioners for IT Cooling

- Direct expansion, air-cooled
- Prepared for remote air cooled condenser coupling;
- Inverter driven BLDC compressors for modulating cooling capacity in response to data centre load variations;
- Plug fans of proprietary design with external rotor EC electric motors;
- Single or dual cooling circuit.
- Dual Fluid version available: the unit is equipped with two separate coils, one chilled water and one direct expansion.

The series, for perimeter installation, consists of 10 models available in the following versions:

- Air delivery upwards (Over) with air intake from the front through a honeycomb grille and air delivery upwards.
- Air supply downwards (Under) with air intake from the top of the machine and air supply downwards.

Cooling capacity: 30 ÷ 140 kW

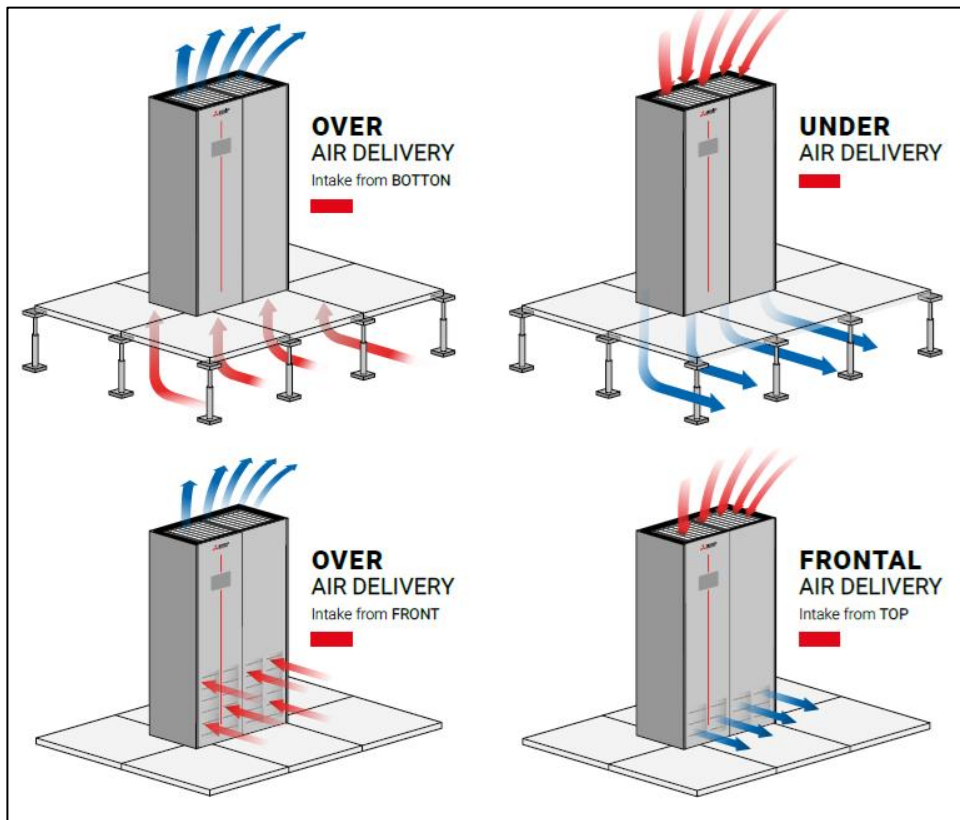

The machines are designed for internal installation. Construction solutions and internal layout allow high application flexibility and front access to the main components for inspection and routine maintenance.

The units require refrigerant gas charging, electrical and hydraulic connections. End-of-line test consisting of a functional test with reading and monitoring of operating parameters, alarm simulation, visual inspection.

## INSTALLATION



### AIR SUPPLY (U - UNDER)

Application suitable for server racks with ventilated front and rear doors. The typical installation is a perimeter installation, the units are placed along the walls of the room. Air distribution is from below, via the plenum formed by the floor of the building and the raised floor.

This solution is normally used in hi-tech air conditioning and is particularly suitable when the thermal load is distributed evenly in all areas of the room. The air is distributed by means of special diffusion tiles positioned in front of the row of racks. Hot air is expelled to the rear of the racks. For optimal installation, it is advisable to provide compartmentalisation of the cold aisle.



### OVER AIR SUPPLY (O - OVER)

Application suitable for server racks with ventilated front and rear doors. The typical installation is a perimeter installation, the units are placed along the walls of the room. Air distribution is from the top of the unit directly into the room or via plenum or ducting. It is possible, through the application of a plenum with grilles on the supply air of the unit, to direct the flow through the adjustable fins of the grilles.

The system is normally applied in installations where it is not possible to provide a raised floor.

On request, in order to limit the acoustic dissipation in the environment, it is possible to supply a closing panel on the bottom, made of hot-galvanised sheet steel insulated with a special sound-absorbing material. This option is particularly suitable for installations on special floors (raised floors, wooden floors, etc.).

The basement closing panel is supplied assembled inside the basement and does not change the dimensions of the unit.



## THE SERIES

### UNDER (M - L - XL)

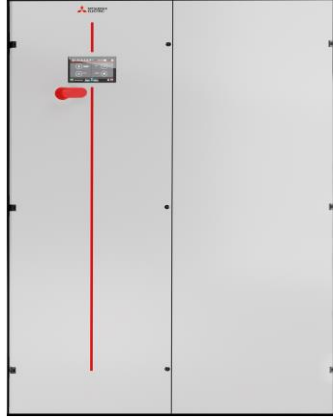
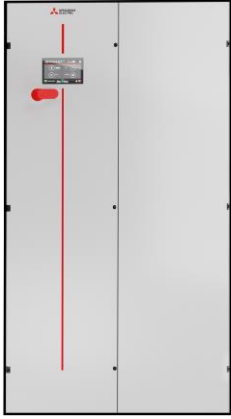

### OVER (M - L - XL)

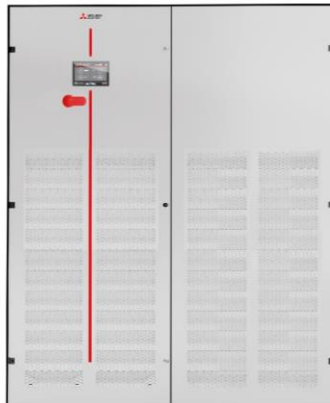
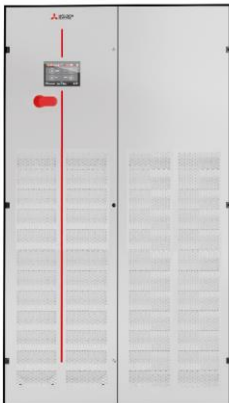

## PRODUCT FEATURES AND BENEFITS

- Different compressors per circuit, with single BLDC inverter compressor or BLDC inverter compressor in combination with ON/OFF compressor, ensure maximum energy efficiency in all operating conditions
- New Plug Fans of proprietary design with EC electric motors and composite material impeller (with recycled polymer base) ensuring reduced power consumption
- New maintenance-free fan motors;
- Fully modulating, able to follow the load increase of the data centre;
- Improved control software with advanced logic;
- Single or dual cooling circuit;
- Intake air temperature up to 40°C.

## F-GAS DIRECTIVE

The units highlighted in this publication contain the fluorinated greenhouse gas <HFC R410A [GWP100 2088]>.

## MODEL IDENTIFICATION

### Air conditioners for IT Cooling

Model: x-MEXT-i-G02-DX-O-029

| x-MEXT | Serie   |
|--------|---|
| -i-    | <b>Compressor type</b><br>i = inverter<br>f = fixed speed   |
| -G02-  | <b>Refrigerant R410A</b>  |
| -DX-   | <b>Version</b><br>DX = direct expansion<br>DF = Dual Fluid: direct expansion + chilled water coil<br>DW = direct expansion, water cooled<br>DW FC = direct expansion + FC coil, water cooled<br>DW DF = Dual Fluid: direct expansion + chilled water coil, water cooled |
| -O-    | <b>Air supply</b><br>O = over air supply<br>U = under air supply  |
| -029-  | <b>Model / Cooling capacity (kW)</b>  |

## TRANSPORT AND STORAGE TEMPERATURE

During transport and if the machine is not installed on receipt, place it in its packaging in a closed, dry and sun-protected environment at a temperature between -30°C and 50°C with no surface condensation.

## OPERATING LIMITS

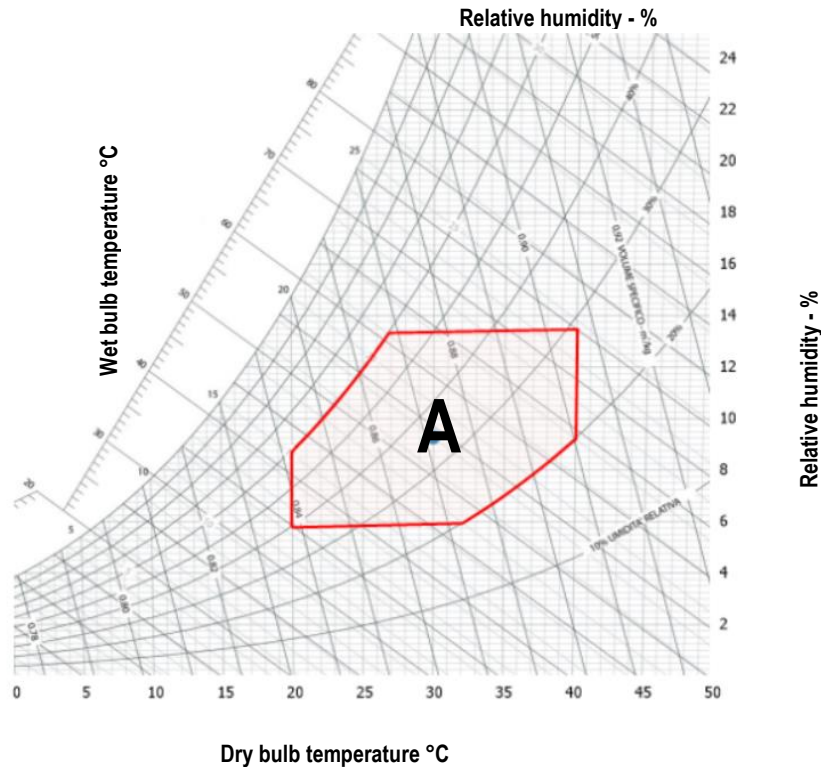

### ROOM AIR CONDITIONS

Room air temperature:

- 12,5°C minimum temperature with wet bulb.
- 24,5°C maximum temperature with wet bulb.
- 20°C minimum temperature with dry bulb.
- 40°C maximum temperature with dry bulb..

### AREA "A". Unit operating envelope.

Room air humidity:

- 20%UR minimum relative humidity.
- 60%UR maximum relative humidity

### EXTERNAL AMBIENT AIR TEMPERATURE

- 45°C - 50 °C depending on combination with external condensing unit
- 20°C Minimum ambient air temperature

### CHILLED WATER TEMPERATURE (Dual Fluid version)

- 6°C - 25 °C water inlet temperature range
- ΔT 3°C minimum temperature difference between chilled water inlet and outlet
- ΔT 10°C maximum temperature difference between chilled water inlet and outlet

### HYDRAULIC CIRCUIT (Dual Fluid system)

- ΔP 5-150 kPa allowed pressure drop on hydraulic circuit
- 16 bar maximum operating pressure of the hydraulic circuit

All values are to be considered as indicative.

Operating temperatures are influenced by a number of variables such as:

- Unit operating conditions;
- Refrigeration load of the data centre;
- Microprocessor control settings.

### POWER SUPPLY

- ± 10% Maximum supply voltage tolerance (V)
- ± 2% Maximum unbalance between phases

## MAIN COMPONENTS

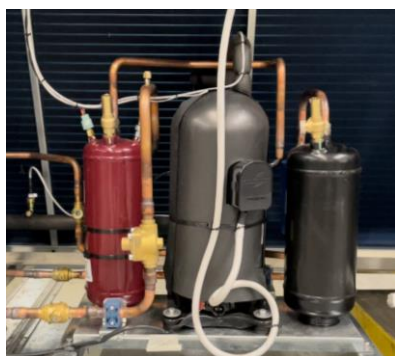
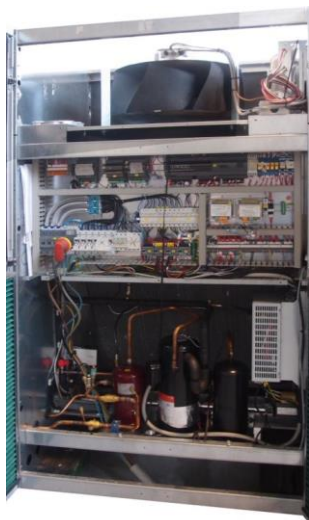

### FRAMEWORK

- The structure is designed to ensure complete frontal accessibility of all components requiring adjustment and routine maintenance
- Internal sheet steel panelling with protective surface treatment according to UNI ISO 9227/ASTMB117 and ISO 7253.
- Front aesthetic panels colour RAL 9006 with wrinkled finish, hinged with quick release system to simplify removal.
- Side and rear aesthetic panels colour RAL 7016 with wrinkled finish, fully removable.
- Panelling insulated internally with polyurethane foam mat
- Air flow OVER version:
  - Air intake from the front through honeycomb grille and air flow upwards
  - Air intake from the bottom base and air discharge to the top
- Air flow UNDER version
  - Air intake from the top and air supply downwards.
  - Air intake from above and air discharge to the front with basement closure.
- Containment compartment for electrical panel on front side for direct access to adjustment and control components;

### FILTER SECTION

- Air filters with 60% COARSE efficiency (according to ISO EN 16890), with synthetic fibre filter media for high aeraulic efficiency.
- Access to air filters:
  - OVER version
    - for all machines front access
  - UNDER version
    - for all machines filter extraction is from the top
- Dirty filter sensor for signalling via air-side differential pressure switch.

### BLDC INVERTER COMPRESSOR SECTION

For unit sizes M (all sizes), L (052), XL (078-090):

- BLDC inverter driven scroll compressors for refrigerant R410A
- Inverter driven brushless synchronous motor
- Driver for compressor speed modulation in response to changes in cooling demand
- Reactor for noise and electromagnetic interference reduction

For unit sizes L (067-076) and XL (108-140):

- One BLDC inverter compressor + one on/off compressor per refrigerant circuit
- On/off compressor features:
  - ON/OFF scroll compressor with spiral profile optimised for refrigerant R410A.
  - Three-phase 2-pole electric motor with direct starting.

### FOR ALL COMPRESSORS:

- Crankcase heater for each compressor
- Acoustic insulation hood for each compressor to reduce the sound level of the unit.
- Anti-vibration rubber mounts

### FAN SECTION

The fan section is contained within the machine and comprises:

- Centrifugal fans with backward curved blades of proprietary design, without scroll (Plug-Fan), directly coupled to external rotor electric motor.
- Impeller made of composite material with 100% recycled polymer base.
- Brushless type EC synchronous electric motor with integrated electronic commutation system with continuous speed variation. Motor speed regulation is achieved via the "EC" (Electronic Commutation) system, which controls the motor based on a signal from the microprocessor control.

- Fan control via ModBus. In the event of a fault, the control stops the fan concerned, indicating the type of fault. A machine with more than one fan is not stopped.
- Adjustable head.

## COOLING SECTION – DIRECT EXPANSION COIL



### M and L size units:

- All-aluminium micro-channel evaporator, a solution that allows the refrigerant charge in the circuit to be kept to a minimum and reduces the pressure drop on the air side of the machine, thus increasing the overall efficiency of the unit
- Peraluman coil support frame with integrated filter support
- Peraluman condensate water collector with flexible PVC drain.
- Intake and supply air temperature probes for regulating and monitoring unit operation.
- Flood sensor (with positioning on the room floor) for alarm indication in the event of water presence.

### XL size units:

- Finned pack heat exchanger with copper tubes and high-efficiency aluminium fins, specifically developed to ensure a high heat exchange coefficient and low pressure drops.
- Filter support frame upstream of the evaporator with integrated filter support
- Peraluman condensate water collector with flexible PVC drain.
- Intake and supply air temperature probes for regulating and monitoring unit operation.
- Flood sensor (with positioning on the room floor) for alarm indication in the event of water presence.

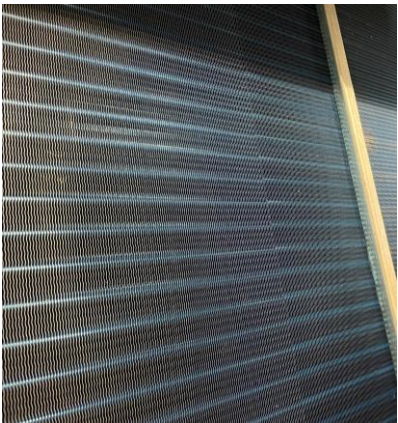

## COOLING SECTION – CHILLED WATER COIL (Dual Fluid version)

- 4-row water cooling coil with copper tubes, aluminium finning and hot-dip galvanised sheet metal frame.
- Motorised 2-way valve with 0-10 VDC control and emergency manual override
- Temperature probe on water inlet
- Copper water pipes with anti-condensation insulation

## REFRIGERANT CIRCUIT

The air conditioner is supplied with a nitrogen sealing charge.  
Components for each cooling circuit:

- Electronic expansion valve. The valve enables high system performance and efficiency thanks to a precise response to temperature and pressure variations.
- Liquid and moisture indicator.
- Filter drier and deacidifier on the liquid line.
- Pressure transducers with indication, control and protection function on the high and low pressure lines.
- Safety pressure switch with manual reset on the high pressure line.
- Liquid receiver
- Oil separator at compressor outlet
- Safety valve on oil separator and liquid receiver
- Copper refrigerant piping with anti-condensation insulation on suction line.
- Lubricating oil charge
- Taps on gas delivery and liquid return for connection to remote air condenser.
- Proportional 0-10V signal for remote air condenser condensation control system.
- Condensation control with continuous variation of remote condenser fan speed for operation at outside temperatures down to -20°C.





## ELECTRICAL PANEL

In accordance with EN60204-1, suitable for indoor installation, complete with

- General lock-door disconnecter on front panel;
- Magneto-thermal protection switches for compressors and fans.
- Remote control switches for compressor ON/OFF, heating elements and humidifier (when optional). BLDC inverter compressors and treatment fans with EC electric motor do not have contactors.
- Transformer for powering auxiliary circuits and microprocessor.
- Numbered electrical cables.
- Terminal block for:

### OUTPUTS

- Voltage-free deviation contact for general alarm 1,2.
- Voltage-free contact for fan system status signalling.
- Voltage-free contact smoke/fire sensor (sensors are accessory)

### INPUTS

- Remote enabling.
- Supply voltage: 400/3/50.

## CONTROL SYSTEM

Microprocessor for monitoring the operating states of the unit.

- The system includes:
- Integrated clock for displaying/storing date and time of alarms;
- Internal memory for recording events that have occurred;
- Provision for housing additional connectivity board: MODBUS, LON, BACNET MS/TP RS485, BACNET OVER IP. Electronic boards are accessory;
- Main component operating hours counter;
- Flash" memory for data storage in the event of power failure;
- Menu-driven management with password protection;
- Demand Limit function (only for units with double refrigerant circuit);
- LAN connection (max 15 units).

## REMOTE CONDENSER



- Peraluman aluminium alloy remote air condensers with microchannel condenser coil:
- with AC axial fan and standard acoustic enclosure **MEGR-MC-A**
- with AC axial fan and low-noise acoustic enclosure **MEGR-MC-SL-A**
- with EC axial fan and standard acoustic enclosure **MEGR-MC-E**
- with EC axial fan and low-noise acoustic enclosure **MEGR-MC-SL-E**

Remote air cooled condensers with copper tubes and aluminium fins:

- with AC axial fan and standard acoustic enclosure **MEGR-TF-A**
- with AC axial fan and low-noise acoustic enclosure **MEGR-TF-SL-A**
- with EC axial fan and standard acoustic enclosure **MEGR-TF-E**
- with EC axial fan and low-noise acoustic enclosure **MEGR-TF-SL-E**

## STANDARD EQUIPMENT



### STANDARD EQUIPMENT ELECTRONIC EXPANSION VALVE

The electronic expansion valve serves to precisely control overheating under various environmental conditions and is regulated by the controller.



### 6192 – COMPACT KEYBOARD

The unit is equipped with the controller connected to a 6-button keyboard and graphic display on which all information is displayed in English or with easily identifiable symbols.



### A491 – FLOOD SENSOR

The system includes an electronic relay installed in the electrical panel of the machine and a water detector.

The electrical connections for the probe and the alarm contact are present in the machine's terminal board.

Sensor is supplied to be connected and installed at customer care.



### B670 – UPPER PROTECTION GRILLE

In the OVER units the top protective grille is provided, it is possible to request that the grille be removed (combination with plenum/ducting).

### A181 – COMPRESSOR SOUNDPROOF JACKET

The system includes a soundproof jacket for each compressor to obtain a reduction of the sound level of the unit.



### A501 – CLOGGED FILTER SENSOR

The system includes a differential pressure switch installed in the electrical panel or in the front of the indoor unit and the plastic hoses for the relief of the pressure upstream and downstream the air filters.

Control range: 0.3 ... 4.0 mbar (30 ... 400 Pa) .

Differential for intervention: 0.15 mbar (15 Pa).



### B804 2 WAY VALVE 0/10V - (DX DF VERSION)

The water flow control in the finned coil is carried out by a 2-way modulating ball valve of the equipcentage type with characterisation disc.

## Air supply UNDER / OVER

| Air supply (1)                       |                     | U / O       | U / O       | U / O       | U / O       | U / O       |
|--------------------------------------|---------------------|-------------|-------------|-------------|-------------|-------------|
| <b>MODEL</b>                         |                     | <b>029</b>  | <b>040</b>  | <b>051</b>  | <b>052</b>  | <b>067</b>  |
| <b>FRAME</b>                         |                     | <b>M</b>    | <b>M</b>    | <b>M</b>    | <b>L</b>    | <b>L</b>    |
| <b>COOLING CAPACITY (2)</b>          |                     | <b>100%</b> | <b>100%</b> | <b>100%</b> | <b>100%</b> | <b>100%</b> |
| Total                                | [kW]                | 29,0        | 40,2        | 51,1        | 52,2        | 66,6        |
| Sensible                             | [kW]                | 29,0        | 40,2        | 51,1        | 52,2        | 66,6        |
| SHR (3)                              |                     | 1,00        | 1,00        | 1,00        | 1,00        | 1,00        |
| Total power input<br>(Comp. + Fans.) | [kW]                | 7,23        | 10,7        | 15,6        | 13,1        | 18,4        |
| <b>"EC" SUPPLY FANS</b>              | [n]                 | 1           | 1           | 1           | 2           | 2           |
| Air flow                             | [m <sup>3</sup> /h] | 8000        | 10500       | 11000       | 14750       | 17000       |
| Nominal external static pressure     | [Pa]                | 20          | 20          | 20          | 20          | 20          |
| Power input (4)                      | [kW]                | 0,80        | 1,61        | 1,85        | 2,16        | 3,20        |
| <b>COMPRESSOR</b>                    |                     | Scroll      | Scroll      | Scroll      | Scroll      | Scroll      |
| BLDC compressor                      | [n]                 | 1           | 1           | 1           | 1           | 1           |
| ON/OFF compressor                    | [n]                 | 0           | 0           | 0           | 0           | 1           |
| Cooling capacity control             |                     | Modulating  | Modulating  | Modulating  | Modulating  | Modulating  |
| Compressor power input               | [kW]                | 6,43        | 9,08        | 13,7        | 11,0        | 15,2        |
| <b>AIR FILTERS</b>                   | [n]                 | 2           | 2           | 2           | 3           | 3           |
| Efficiency (ISO EN 16890)            | COARSE              | 60%         | 60%         | 60%         | 60%         | 60%         |
| <b>GAS circuits</b>                  | [n]                 | 1           | 1           | 1           | 1           | 1           |
| <b>POWER SUPPLY</b>                  | V/Ph/Hz             | 400/3/50    | 400/3/50    | 400/3/50    | 400/3/50    | 400/3/50    |
| <b>ENERGY EFFICIENCY INDEX (2)</b>   |                     |             |             |             |             |             |
| EER - Energy Efficiency Ratio (5)    | [kW/kW]             | 4,01        | 3,76        | 3,28        | 3,98        | 3,62        |
| <b>DIMENSIONS</b>                    |                     |             |             |             |             |             |
| Length                               | [mm]                | 1142        | 1142        | 1142        | 1600        | 1600        |
| Width                                | [mm]                | 885         | 885         | 885         | 885         | 885         |
| Height                               | [mm]                | 1980        | 1980        | 1980        | 1980        | 1980        |
| <b>NET WEIGHT Over</b>               | [kg]                | 363         | 372         | 375         | 459         | 502         |
| <b>NET WEIGHT Under</b>              | [kg]                | 372         | 380         | 383         | 477         | 520         |
| <b>REFRIGERANT CONNECTIONS</b>       |                     |             |             |             |             |             |
| gas supply                           | [mm Ø]              | 18          | 22          | 22          | 22          | 28          |
| Liquid return                        | [mm Ø]              | 16          | 18          | 18          | 18          | 18          |
| <b>HYDRAULIC CONNECTIONS</b>         |                     |             |             |             |             |             |
| <b>CONDENSATE DISCHARGE</b>          |                     |             |             |             |             |             |
| Rubber pipe – internal diameter      | [mm Ø]              | 19          | 19          | 19          | 19          | 19          |

### THE COOLING CAPACITY DOES NOT CONSIDER THE SUPPLY FAN MOTOR THERMAL LOAD

1. U = Under, Downflov / O = Over, Upflow
2. Gross value. Parameters referred to entering air at 30°C - 35% RH; condensing temperature 45°C; ESP=20Pa.
3. SHR = Sensible cooling capacity / Total cooling capacity
4. Corresponding to the nominal external static pressure.
5. The Energy Efficiency Index does not consider the remote air-cooled condenser.

The units highlighted in this publication contain <HFC R410A [GWP100 2088]> fluorinated greenhouse gas.

### NOTE:

Below 30% of cooling capacity, the inverter compressor enters the "cycling" area in which the compressor operates with ON / OFF cycles below the minimum modulation frequency (operation only for short periods).  
SELECT THE UNIT IN THE MODULATION FIELD.



# TECHICAL DATA

x-MEXT DX / DF

Data Book

DB\_ME\_x-MEXT-i-G02-DX\_102022\_EN\_rev02

| Air supply (1)                       |                     | U / O         | U / O         | U / O         | U / O         | U / O         |
|--------------------------------------|---------------------|---------------|---------------|---------------|---------------|---------------|
| <b>MODEL</b>                         |                     | <b>076</b>    | <b>078</b>    | <b>090</b>    | <b>108</b>    | <b>140</b>    |
| <b>FRAME</b>                         |                     | <b>L</b>      | <b>XL</b>     | <b>XL</b>     | <b>XL</b>     | <b>XL</b>     |
| <b>COOLING CAPACITY (2)</b>          |                     | <b>100%</b>   | <b>100%</b>   | <b>100%</b>   | <b>100%</b>   | <b>100%</b>   |
| Total                                | [kW]                | 76,1          | 78,7          | 90,9          | 108           | 140           |
| Sensible                             | [kW]                | 76,1          | 78,7          | 90,9          | 108           | 140           |
| <b>SHR (3)</b>                       |                     | <b>1,00</b>   | <b>1,00</b>   | <b>1,00</b>   | <b>1,00</b>   | <b>1,00</b>   |
| Total power input<br>(Comp. + Fans.) | [kW]                | 22,3          | 19,4          | 23,7          | 30,1          | 44,8          |
| <b>"EC" SUPPLY FANS</b>              | [n]                 | <b>2</b>      | <b>2</b>      | <b>2</b>      | <b>3</b>      | <b>3</b>      |
| Air flow                             | [m <sup>3</sup> /h] | 17000         | 21500         | 22500         | 25500         | 27000         |
| Nominal external static pressure     | [Pa]                | 20            | 20            | 20            | 20            | 20            |
| Power input (4)                      | [kW]                | 3,22          | 3,21          | 3,66          | 5,15          | 6,24          |
| <b>COMPRESSOR</b>                    |                     | <b>Scroll</b> | <b>Scroll</b> | <b>Scroll</b> | <b>Scroll</b> | <b>Scroll</b> |
| BLDC compressor                      | [n]                 | 1             | 2             | 2             | 2             | 2             |
| ON/OFF compressor                    | [n]                 | 1             | 0             | 0             | 2             | 2             |
| Cooling capacity control             |                     | Modulating    | Modulating    | Modulating    | Modulating    | Modulating    |
| Compressor power input               | [kW]                | 19,1          | 16,1          | 20,1          | 24,9          | 38,5          |
| <b>AIR FILTERS</b>                   | [n]                 | <b>3</b>      | <b>4</b>      | <b>4</b>      | <b>4</b>      | <b>4</b>      |
| Efficiency (ISO EN 16890)            | COARSE              | 60%           | 60%           | 60%           | 60%           | 60%           |
| <b>GAS circuits</b>                  | [n]                 | <b>1</b>      | <b>2</b>      | <b>2</b>      | <b>2</b>      | <b>2</b>      |
| <b>POWER SUPPLY</b>                  | V/Ph/Hz             | 400/3/50      | 400/3/50      | 400/3/50      | 400/3/50      | 400/3/50      |
| <b>ENERGY EFFICIENCY INDEX (2)</b>   |                     |               |               |               |               |               |
| EER - Energy Efficiency Ratio (5)    | [kW/kW]             | 3,41          | 4,06          | 3,84          | 3,59          | 3,12          |
| <b>DIMENSIONS</b>                    |                     |               |               |               |               |               |
| Length                               | [mm]                | 1600          | 2550          | 2550          | 2550          | 2550          |
| width                                | [mm]                | 885           | 885           | 885           | 885           | 885           |
| Height                               | [mm]                | 1980          | 1980          | 1980          | 1980          | 1980          |
| <b>NET WEIGHT Over</b>               | [kg]                | <b>503</b>    | <b>799</b>    | <b>806</b>    | <b>915</b>    | <b>916</b>    |
| <b>NET WEIGHT Under</b>              | [kg]                | <b>521</b>    | <b>839</b>    | <b>846</b>    | <b>955</b>    | <b>957</b>    |
| <b>REFRIGERANT CONNECTIONS</b>       |                     |               |               |               |               |               |
| gas supply                           | [mm Ø]              | 28            | 22            | 22            | 28            | 28            |
| Liquid return                        | [mm Ø]              | 18            | 18            | 18            | 18            | 18            |
| <b>HYDRAULIC CONNECTIONS</b>         |                     |               |               |               |               |               |
| <b>CONDENSATE DISCHARGE</b>          |                     |               |               |               |               |               |
| Rubber pipe – internal diameter      | [mm Ø]              | 19            | 19            | 19            | 19            | 19            |

## THE COOLING CAPACITY DOES NOT CONSIDER THE SUPPLY FAN MOTOR THERMAL LOAD

1. U = Under, Downflov / O = Over, Upflow
2. Gross value. Parameters referred to entering air at 30°C - 35% RH; condensing temperature 45°C; ESP=20Pa.
3. SHR = Sensible cooling capacity / Total cooling capacity
4. Corresponding to the nominal external static pressure.
5. The Energy Efficiency Index does not consider the remote air-cooled condenser.

The units highlighted in this publication contain <HFC R410A [GWP100 2088]> fluorinated greenhouse gas.

## NOTE:

Below 30% of cooling capacity, the inverter compressor enters the "cycling" area in which the compressor operates with ON / OFF cycles below the minimum modulation frequency (operation only for short periods).

SELECT THE UNIT IN THE MODULATION FIELD.

## REFRIGERANT CHARGE

The air conditioner is supplied with a minimum R410A refrigerant charge. **Refrigerant must be charged.** The following table shows the refrigerant charge that must be introduced for the air conditioner only. Remote condenser, connections pipes and optional are excluded.

| Air supply (1)                                 |        | U / O     | U / O     | U / O     | U / O     | U / O     |
|--|--------|-----------|-----------|-----------|-----------|-----------|
| <b>MODEL</b>                                   |        | <b>29</b> | <b>40</b> | <b>51</b> | <b>52</b> | <b>67</b> |
| <b>FRAME</b>                                   |        | <b>M</b>  | <b>M</b>  | <b>M</b>  | <b>L</b>  | <b>L</b>  |
| <b>REFRIGERANT</b>                             |        | R410A     | R410A     | R410A     | R410A     | R410A     |
| Gas circuits x Refrigerant charge (2)          | n x kg | 1x5,5     | 1x6,6     | 1x6,7     | 1x7       | 1x8,9     |
| HFC R410A - F Gas - CO <sub>2</sub> equivalent | t      | 11,5      | 13,7      | 14        | 14,6      | 18,6      |

| Air supply (1)                                 |        | U / O     | U / O     | U / O     | U          | U          |
|--|--------|-----------|-----------|-----------|------------|------------|
| <b>MODEL</b>                                   |        | <b>76</b> | <b>78</b> | <b>90</b> | <b>108</b> | <b>140</b> |
| <b>FRAME</b>                                   |        | <b>L</b>  | <b>XL</b> | <b>XL</b> | <b>XL</b>  | <b>XL</b>  |
| <b>REFRIGERANT</b>                             |        | R410A     | R410A     | R410A     | R410A      | R410A      |
| Gas circuits x Refrigerant charge (2)          | n x kg | 1x9       | 2x8,6     | 2x8,7     | 2x10,6     | 2x10,7     |
| HFC R410A - F Gas - CO <sub>2</sub> equivalent | t      | 18,8      | 35,9      | 36,3      | 44,7       | 44,7       |

1. U = Under, downflow / O = Over, upflow

2. Refrigerant charge required for the air conditioner only operation. Remote condenser, connections pipes and optional are excluded.

For air conditioners with double refrigerant circuit is indicated the number of circuits x the charge of a single circuit.

## PRESSURE RELIEF VALVE

The pressure relief valve of the refrigerant circuit is installed in the machines when required by Directive 2014/68/EU.

The valve is installed on liquid receiver and oil separator of each refrigerant circuit of the machine with the purpose to protect the circuit from overpressure.

**It is up to the installer to check whether the system complies with the 2014/68 / EU standard regarding the installation of the pressure relief valve.**

**By plant we mean the complete system that includes the internal machine, the remote condenser and the connecting pipes**

The installer must calculate the amount of refrigerant contained in the system and, if the refrigerant charge is higher than 10 kg, he must install the pressure relief valve.

| Model      | Pressure relief valve on liquid receiver [bar] | Pressure relief valve on oil separator [bar] | Possible pressure relief valve in addition (by the installer) [bar] |
|------------|--|--|---|
| <b>29</b>  | 41,5   | 41,5   | 41,5  |
| <b>40</b>  | 41,5   | 41,5   | 41,5  |
| <b>51</b>  | 41,5   | 41,5   | 41,5  |
| <b>52</b>  | 41,5   | 41,5   | 41,5  |
| <b>67</b>  | 41,5   | 41,5   | 41,5  |
| <b>76</b>  | 41,5   | 41,5   | 41,5  |
| <b>78</b>  | 41,5   | 41,5   | 41,5  |
| <b>90</b>  | 41,5   | 41,5   | 41,5  |
| <b>108</b> | 41,5   | 41,5   | 41,5  |

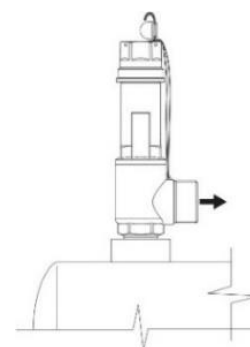

Exhaust flow  
CONNECTION Ø 3/4" G - M

## RECOMMENDED REFRIGERATION LINES

Recommended refrigerant line diameters for connection to MEHITS S.p.A. air conditioners and refer to the "EQUIVALENT LENGTH". Please always refer to the "INSTALLATION SCHEME " to correctly select all necessary components. Check the need to use pressure limiting devices (safety valves) where not already provided for in Directive 2014/68/EU.

Nominal diameter: refrigerant connection of the indoor unit. In some cases the diameter of the refrigerant lines may not correspond with the nominal diameter. This is completely normal; it is sufficient to provide a reduction fitting to adjust the diameter.

## PIPE DIAMETERS

| SI       | Ø [mm]         | 16   | 18   | 22   | 28     |
|----------|----------------|------|------|------|--------|
|          | thickness [mm] | 1    | 1    | 1    | 1,5    |
| IMPERIAL | Ø [inches]     | 5/8" | 3/4" | 7/8" | 1 1/8" |
|          | thickness [mm] | 1    | 1    | 1    | 1,25   |

| MODEL  |                | P_nom [kW] | Ø [mm] | Equivalent length [m] |    |    |    |    |    |         |    |    |    |    |
|--------|----------------|------------|--------|-----------------------|----|----|----|----|----|---------|----|----|----|----|
|        |                |            |        | 5                     | 10 | 15 | 20 | 25 | 30 | 35      | 40 | 45 | 50 | 75 |
| 29 M   | Supply gas     | 29         | 18     | Ø 18 mm               |    |    |    |    |    | Ø 22 mm |    |    |    |    |
|        | Return liquido |            | 16     | Ø 16 mm               |    |    |    |    |    | Ø 18 mm |    |    |    |    |
| 40 M   | Supply gas     | 40         | 22     | Ø 22 mm               |    |    |    |    |    |         |    |    |    |    |
|        | Return liquido |            | 18     | Ø 18 mm               |    |    |    |    |    | Ø 22 mm |    |    |    |    |
| 51 M   | Supply gas     | 51         | 22     | Ø 22 mm               |    |    |    |    |    | Ø 28 mm |    |    |    |    |
|        | Return liquido |            | 18     | Ø 18 mm               |    |    |    |    |    | Ø 22 mm |    |    |    |    |
| 52 L   | Supply gas     | 52         | 22     | Ø 22 mm               |    |    |    |    |    | Ø 28 mm |    |    |    |    |
|        | Return liquido |            | 18     | Ø 18 mm               |    |    |    |    |    | Ø 22 mm |    |    |    |    |
| 67 L   | Supply gas     | 67         | 28     | Ø 22 mm               |    |    |    |    |    | Ø 28 mm |    |    |    |    |
|        | Return liquido |            | 18     | Ø 18 mm               |    |    |    |    |    | Ø 22 mm |    |    |    |    |
| 76 L   | Supply gas     | 67         | 28     | Ø 22 mm               |    |    |    |    |    | Ø 28 mm |    |    |    |    |
|        | Return liquido |            | 18     | Ø 18 mm               |    |    |    |    |    | Ø 22 mm |    |    |    |    |
| 78 XL  | Supply gas     | 78         | 22     | Ø 22 mm               |    |    |    |    |    |         |    |    |    |    |
|        | Return liquido |            | 18     | Ø 18 mm               |    |    |    |    |    | Ø 22 mm |    |    |    |    |
| 90 XL  | Supply gas     | 90         | 22     | Ø 22 mm               |    |    |    |    |    | Ø 28 mm |    |    |    |    |
|        | Return liquido |            | 18     | Ø 18 mm               |    |    |    |    |    | Ø 22 mm |    |    |    |    |
| 108 XL | Supply gas     | 108        | 28     | Ø 22 mm               |    |    |    |    |    | Ø 28 mm |    |    |    |    |
|        | Return liquido |            | 18     | Ø 18 mm               |    |    |    |    |    | Ø 22 mm |    |    |    |    |
| 140 XL | Supply gas     | 140        | 28     | Ø 22 mm               |    |    |    |    |    | Ø 28 mm |    |    |    |    |
|        | Return liquido |            | 18     | Ø 18 mm               |    |    |    |    |    | Ø 22 mm |    |    |    |    |

For equivalent pipe lengths of more than 100 metres, please contact the manufacturer's sales department.

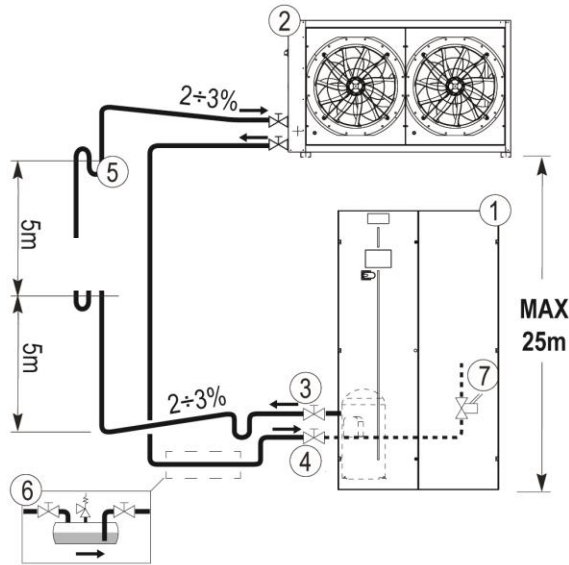

Apply the diagram to each refrigerant circuit of the machine.

Height difference between units in absolute value.

Maximum equivalent length of connecting pipes: 100 m

**LEGENDA**

- 1. Air conditioner
- 2. Remote air condenser
- 3. Gas supply line
- 4. Liquid return line.
- 5. Siphon. Provide a siphon every 5 m of pipework in vertical sections
- 6. Additional liquid receiver, external to the air conditioner - To be provided by the installer.

It is recommended for:

- Installations with refrigeration lines of an equivalent length of more than 25 metres
- Installations with refrigeration lines of any length and operating at outside temperatures below 0°C

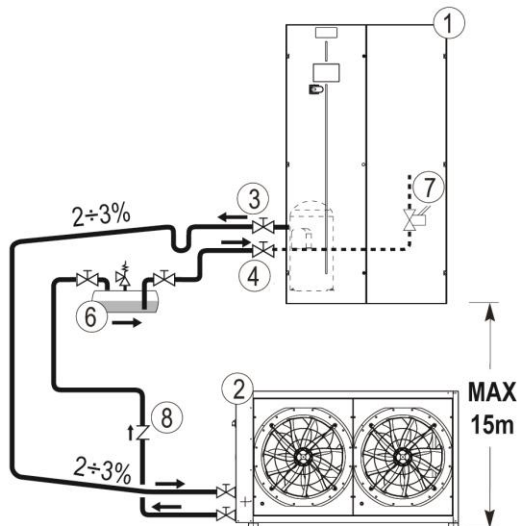

7. Liquid line solenoid valve. Machine accessory recommended for refrigeration installations with lines longer than 10 m.

8. Check valve - To be installed by the installer. The valve must be installed on the liquid line near the condenser. The valve prevents the return of liquid to the condenser, particularly in the case of system shutdown during the winter season.

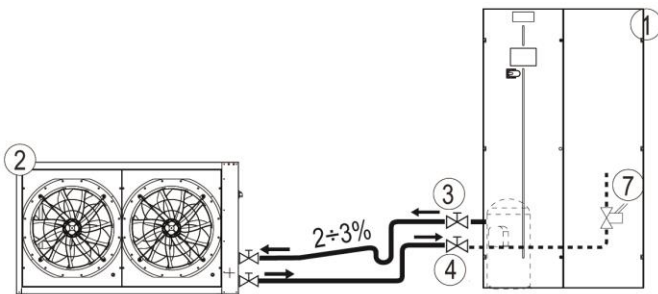

**WARNINGS**

It is necessary to supplement the refrigerant charge and lubricating oil for the connecting pipes and the remote air condenser.

Proceed with refrigerant charge in the appropriate quantities and charge lubricating oil in the proportion of 10% of the refrigerant fed. The oil must be of the same type as that already in the machine as indicated on the compressor's rating plate.

## DUAL FLUID SYSTEM

The DUAL FLUID system allows for a system with two separate cooling sources:

- Chilled water battery;
- Direct expansion coil.

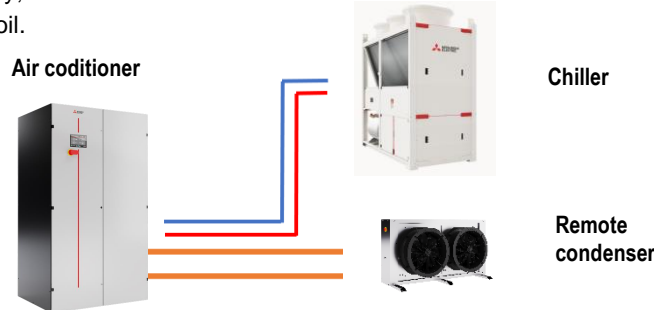

The microprocessor control automatically manages the system, activating the most convenient cooling circuit according to the set parameters. This system allows many system problems to be solved simply and in a small space, including:

- System supplied with well water in reserve to the main cooling circuit.
- Dual supply system with two independent sources. This solution is used when redundancy of the cooling system must be guaranteed. Temperature control is carried out with the same logic as the main coil.

## TECHNICAL DATA CHILLED WATER COIL

| AIR SUPPLY (1)                   |                   | U / O  | U / O  | U / O  | U / O | U / O |
|----------------------------------|-------------------|--------|--------|--------|-------|-------|
| MODEL                            |                   | 29     | 40     | 51     | 52    | 67    |
| FRAME                            |                   | M      | M      | M      | L     | L     |
| COOLING CAPACITY (2)             |                   |        |        |        |       |       |
| Total                            | kW                | 36,2   | 44,5   | 46,1   | 62,8  | 69,6  |
| Sensible                         | kW                | 36,2   | 44,5   | 46,1   | 62,8  | 69,6  |
| SHR (3)                          |                   | 1      | 1      | 1      | 1     | 1     |
| COOLING COIL                     |                   |        |        |        |       |       |
| Water flow (2)                   | m <sup>3</sup> /h | 5,2    | 6,4    | 6,62   | 9,02  | 9,99  |
| dP coil + valve (2)              | kPa               | 33,5   | 48,4   | 51,5   | 38,5  | 46,4  |
| Content water                    | l                 | 9,2    | 9,2    | 9,2    | 12,5  | 12,5  |
| HYDRAULIC CONNECTIONS            |                   |        |        |        |       |       |
| INLET / OUTLET WATER - ISO 7/1 - | Ø                 | 1 1/2" | 1 1/2" | 1 1/2" | 2"    | 2"    |

| AIR SUPPLY (1)                   |                   | U / O | U / O  | U / O  | U      |
|----------------------------------|-------------------|-------|--------|--------|--------|
| MODEL                            |                   | 76    | 78     | 90     | 108    |
| FRAME                            |                   | L     | XL     | XL     | XL     |
| COOLING CAPACITY (2)             |                   |       |        |        |        |
| Total                            | kW                | 69,6  | 96,1   | 99,2   | 109    |
| Sensible                         | kW                | 69,6  | 96,1   | 99,2   | 109    |
| SHR (3)                          |                   | 1     | 1      | 1      | 1      |
| COOLING COIL                     |                   |       |        |        |        |
| Water flow (2)                   | m <sup>3</sup> /h | 9,99  | 13,8   | 14,2   | 15,6   |
| dP coil + valve (2)              | kPa               | 46,4  | 49     | 51,9   | 61,2   |
| Content water                    | l                 | 12,5  | 20,3   | 20,3   | 20,3   |
| HYDRAULIC CONNECTIONS            |                   |       |        |        |        |
| INLET / OUTLET WATER - ISO 7/1 - | Ø                 | 2"    | 2 1/2" | 2 1/2" | 2 1/2" |

### THE COOLING CAPACITY DOES NOT TAKE THE THERMAL LOAD OF THE FAN INTO ACCOUNT

1. U = Under, Downflow / O = Over, Upflow
2. Gross value. Parameters referred to entering air at 30°C-35%UR and chilled water 10-16°C - 0% glycole

**SHR = Sensible cooling capacity / Total cooling capacity**

**2-WAY BALL VALVE FOR CHILLED WATER FLOW CONTROL (Dual Fluid version)**

The water flow control in the finned coil is achieved through a 2-way modulating ball valve with equal percentage flow control ensured by the integrated characterizing disc.



This type of valve offers the following series of benefits:

- Equal percentage flow control.
- No peaks initial flow.
- Excellent stability control thanks to the integrated characterizing disc.
- Excellent characteristic in partialisation.
- Stability in control.
- Maintenance free.
- Self-cleaning.

**CHARACTERISTICS OF THE 2-WAY BALL VALVE**

- Closing seal with leakage rate in Class A (EN 12266-1)
- Maximum fluid pressure  $P_s=1600\text{kPa}$
- Maximum closing pressure (Close-off)  $\Delta P_s=1400\text{kPa}$

The rotative actuator is controlled by a signal 0 ... 10VDC from the microprocessor controller. The actuator is equipped with an emergency button for manual operation and is maintenance-free.

**WATER QUALITY OF THE HYDRAULIC CIRCUITS**

The values shown in the table must be guaranteed during the entire life cycle of the machine

|    | Description                                 | Symbol   | Range      |
|----|---|--|------------|
| 1  | Hydrogen ions                               | pH   | 7.5 ÷ 9    |
| 2  | Presence of calcium (Ca) and magnesium (Mg) | Hardness   | 4 ÷ 8.5 °D |
| 3  | Chlorine ions                               | Cl <sup>-</sup>  | < 150 ppm  |
| 4  | Iron ions                                   | Fe <sup>3+</sup>   | < 0.5 ppm  |
| 5  | Manganese ions                              | Mn <sup>2+</sup>   | < 0.05 ppm |
| 6  | Carbon dioxide                              | CO <sub>2</sub>  | < 10 ppm   |
| 7  | Hydrogen sulphide                           | H <sub>2</sub> S   | < 50 ppb   |
| 8  | Oxygen                                      | O <sub>2</sub>   | < 0.1 ppm  |
| 9  | Chlorine                                    | Cl <sub>2</sub>  | < 0.5 ppm  |
| 10 | Ammonia NH <sub>3</sub>                     | NH <sub>3</sub>  | < 0.5 ppm  |
| 11 | Ratio between carbonates and sulphates      | HCO <sub>3</sub> <sup>-</sup> /SO <sub>4</sub> <sup>2-</sup> | > 1        |
| 12 | Sulphate ions                               | SO <sub>4</sub> <sup>-</sup>                                 | < 100 ppm  |
| 13 | Phosphate ions                              | PO <sub>4</sub> <sup>3-</sup>                                | < 2.0 ppm  |

Where:  $1/1.78^\circ\text{D} = 1^\circ\text{Fr}$  con  $1^\circ\text{Fr} = 10 \text{ gr CaCO}_3 / \text{m}^3$

ppm = parts for millions

ppb = parts for billion

Explanatory notes:

ref.1: A greater concentration of hydrogen ions (pH) than 9 implies a high risk of deposits, whereas a lower pH than 7 implies a high risk of corrosion.

ref.2: The hardness measures the amount of Ca and Mg carbonate dissolved in the water with a temperature lower than 100°C (temporary hardness). A high hardness implies a high risk of deposits.

ref.3: The concentration of chloride ions with higher values than those indicated causes corrosion.

ref. 4 - 5 - 8: The presence of iron and manganese ions and oxygen leads to corrosion.

ref.6 - 7: Carbon dioxide and hydrogen sulphide are impurities that promote corrosion.

ref.9: Usually in water from the waterworks it is a value of between 0.2 and 0.3 ppm. High values cause corrosion.

ref.10: The presence of ammonia reinforces the oxidising power of oxygen

ref.11: Below the value shown in the table, there is a risk of corrosion due to the trigger of galvanic currents between copper and other less noble metals.

ref.12: The presence of sulphates ions triggers corrosion phenomenon.

ref.13: The presence of phosphates ions triggers corrosion phenomenon.

It is necessary to carry out periodic checks, with withdrawals at different points of the hydraulic system. During the first year of operation, checks are recommended every 4 months which can be reduced every 6 months starting from the second year of operation.

**WARNING:**

Values of the parameters outside the indicated ranges can lead to the formation of deposits and limescale and/or favour corrosive phenomena within the plant. For operating fluids other than water (mixtures of ethylene and propylene glycol) it is recommended to use specific inhibitors, designed to offer thermal stability within the operating temperature range and protection against corrosion. It is necessary that, in the presence of dirty and / or aggressive waters, an intermediate heat exchanger is installed upstream of the heat exchangers

**ANTIFREEZE MIXTURES**

In systems that are not adequately protected by electric heaters, protect the water circuit with anti-freeze mixture when the outside air temperature may fall below 5°C.

|                  |                                 | % suggerita in peso |   |    |    |     |     |     |     |     |
|------------------|---------------------------------|---------------------|---|----|----|-----|-----|-----|-----|-----|
|                  |                                 | %                   | 0 | 12 | 20 | 30  | 35  | 40  | 45  | 50  |
| ETHYLENE GLYCOL  | Minimum outdoor air temperature | °C                  | 5 | 0  | -5 | -10 | -15 | -20 | -25 | -30 |
| PROPYLENE GLYCOL | Minimum outdoor air temperature | °C                  | 5 | 2  | -3 | -9  | -13 | -17 | -23 | -29 |

The values are indicative and may significantly vary depending on the glycol manufacturer. Refer to your glycol supplier for detail.

The values consider a precautionary difference of 5°C between the minimum ambient air temperature and the freezing temperature of the mixture.

In the hydraulic circuit do not send fluids other than water or mixtures with ethylene / propylene glycol.

If other products are provided, in addition to mixtures of water and ethylene or propylene glycol, contact the Manufacturer to check the compatibility with the machine components.

## REFRIGERANT CIRCUIT for DX and DF DX versions

Below refrigerant diagrams for version with single or double refrigerant circuit. The diagrams refer to the standard configuration, without optional.

### DX / DF DX UNDER – SINGLE REFRIGERANT CIRCUIT

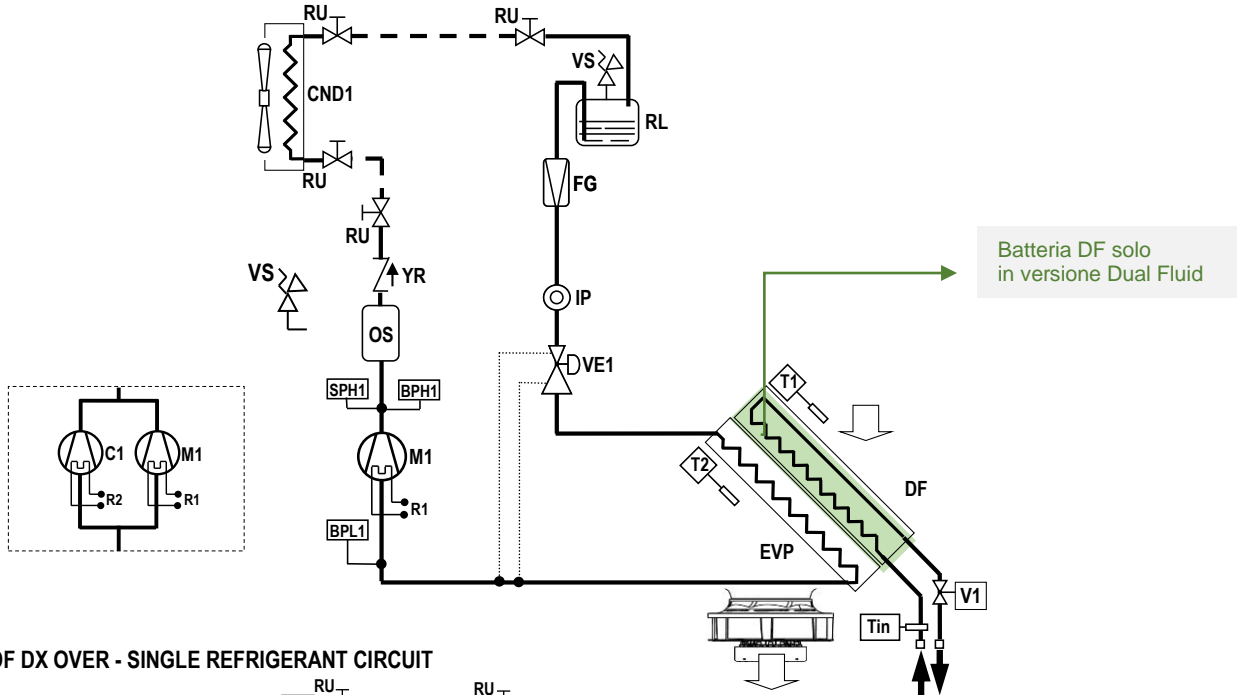

### DX / DF DX OVER - SINGLE REFRIGERANT CIRCUIT

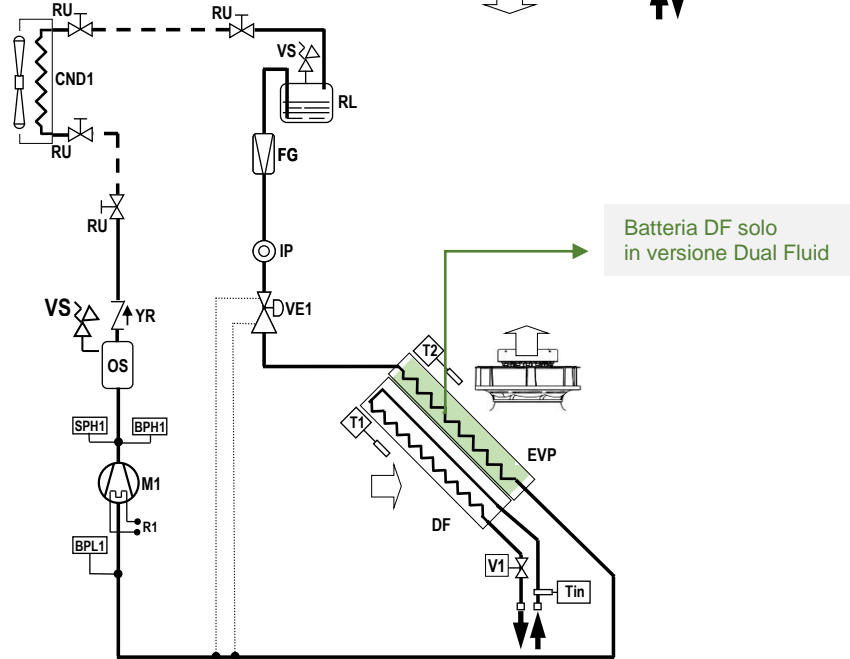

#### LEGENDA

- M1 / M2: BLDC inverter 1 / 2 compressore
- C1 / C2: ON/OFF compressor 1 / 2
- R1 / R2: compressor carter heater
- CND: condensatore
- EVP: evaporatore
- BPH: High pressure transducer
- BPL: Low pressure transducer
- YR: non-return valve
- VS: relief valve
- FG: refrigerant gas FILTER
- OS: oil separator
- IP: Passage indicator
- VE: Exspansion valve
- T: temperature probe
- RU: taps
- RL: liquid receiver
- SPH: high-pressure switch



## DX / DF DX UNDER - DOUBLE REFRIGERANT CIRCUIT

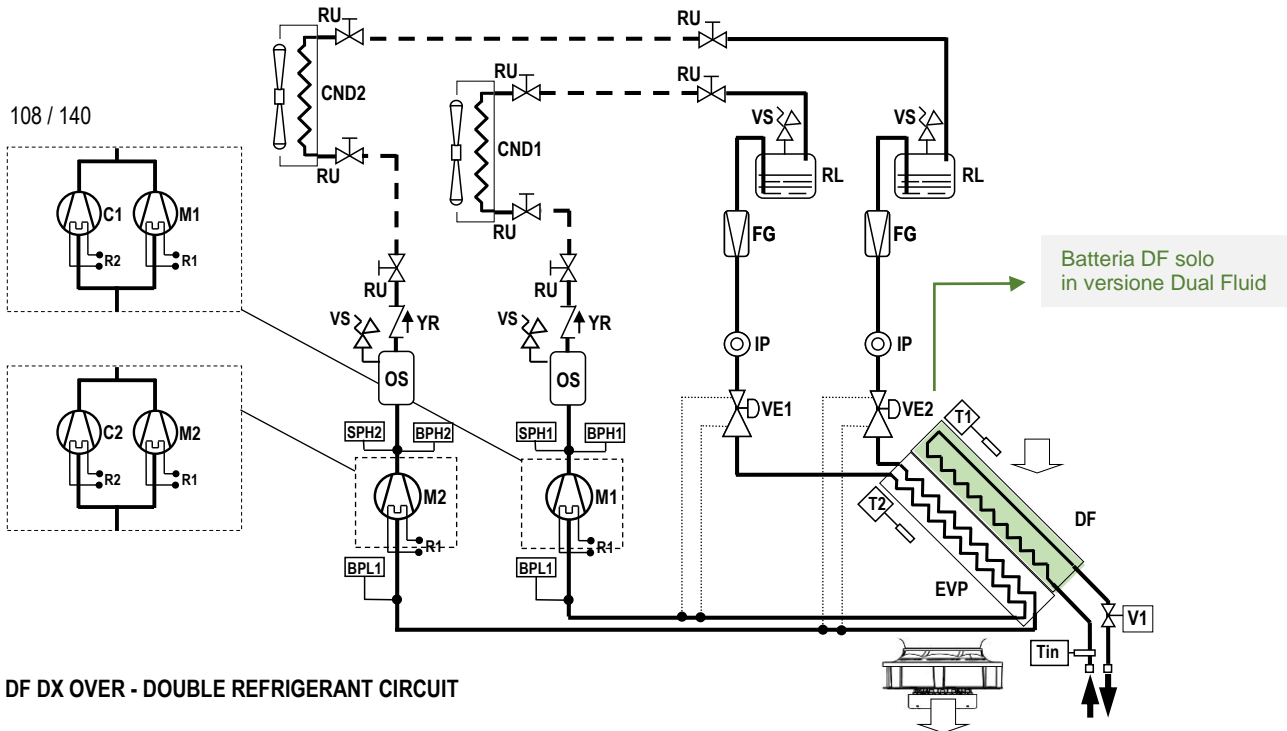

## DX / DF DX OVER - DOUBLE REFRIGERANT CIRCUIT

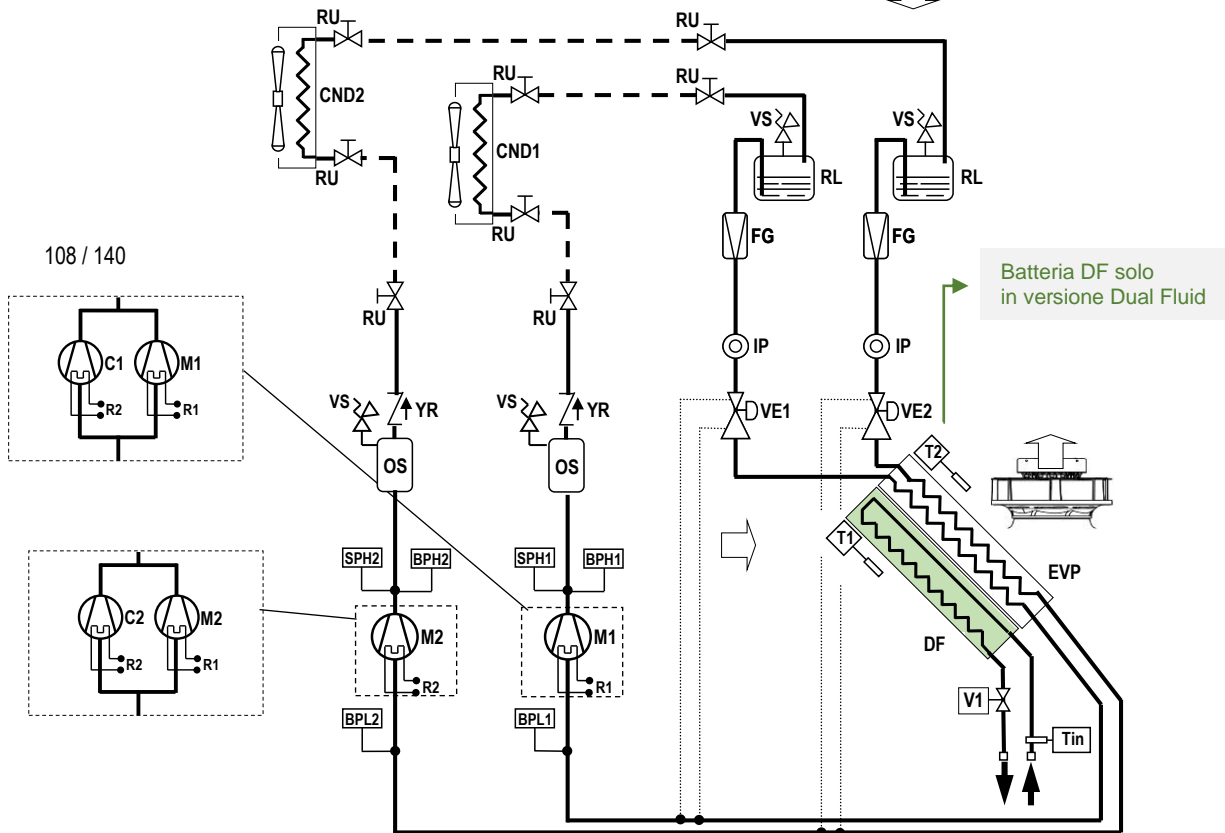

## ACOUSTIC DATA

Acoustic data of the standard machine at full load working conditions.

### WARNING:

In a closed room the noise produced by a sound source reaches the listener in two different ways:

- Directly
- Reflected from the surrounding walls, floor, ceiling, from furniture.

With the same sound source, the noise produced in a closed room is greater than that produced outdoors. In fact, the sound pressure level generated by the source, must be added to the one reflected from the room.

Also, the shape of the room affects the sound.

### Version DX

| Model                           |        | 29   | 40   | 51   | 52   | 67   | 76   | 78   | 90   | 108  | 140  |
|---------------------------------|--------|------|------|------|------|------|------|------|------|------|------|
| Frame                           |        | M    | M    | M    | L    | L    | L    | XL   | XL   | XL   | XL   |
| Cooling capacity                |        | 100% | 100% | 100% | 100% | 100% | 100% | 100% | 100% | 100% | 100% |
| <b>Sound level ISO 3744 (1)</b> |        |      |      |      |      |      |      |      |      |      |      |
| On supply - Under               | dB (A) | 63,4 | 69   | 70   | 67,9 | 70,8 | 70,8 | 70,6 | 71,6 | 72,3 | 73,6 |
| On return - Under               | dB (A) | 64,8 | 62,9 | 62,8 | 62,2 | 62,9 | 62,7 | 64,3 | 64,3 | 64,8 | 64,9 |
| On the front - Under            | dB (A) | 50,7 | 47,9 | 48,1 | 47,5 | 48,3 | 48,2 | 50,1 | 50,2 | 50,5 | 50,9 |
| On supply - Over                | dB (A) | 63,4 | 69   | 70   | 67,9 | 70,8 | 70,8 | 70,6 | 71,6 | 72,3 | 73,6 |
| On return - Over (2)            | dB (A) | 70,1 | 65,8 | 64,8 | 65,8 | 65,9 | 65   | 68,7 | 67,7 | 68,8 | 67,9 |
| On the front - Over (3)         | dB (A) | 52   | 48,5 | 48,5 | 48,2 | 48,4 | 48,3 | 50,8 | 50,8 | 51   | 51,1 |

1. Noise pressure level at 1 meter in free field – ISO 3744
2. Air intake from the front
3. Air intake from the bottom

### Version DX DF

| Model                           |        | 29   | 40   | 51   | 52   | 67   | 76   | 78   | 90   | 108  |
|---------------------------------|--------|------|------|------|------|------|------|------|------|------|
| Frame                           |        | M    | M    | M    | L    | L    | L    | XL   | XL   | XL   |
| Cooling capacity                |        | 100% | 100% | 100% | 100% | 100% | 100% | 100% | 100% | 100% |
| <b>Sound level ISO 3744 (1)</b> |        |      |      |      |      |      |      |      |      |      |
| On supply - Under               | dB (A) | 60,2 | 66,1 | 67,1 | 60,8 | 63,9 | 63,9 | 68   | 69   | 64,6 |
| On return - Under               | dB (A) | 60,8 | 59,4 | 59,9 | 58,6 | 58,8 | 59,2 | 60,9 | 61,4 | 60,7 |
| On the front - Under            | dB (A) | 50,6 | 47,5 | 47,5 | 46,8 | 47,1 | 47   | 49,6 | 49,7 | 49,4 |
| On supply - Over                | dB (A) | 60,2 | 66,1 | 67,1 | 60,8 | 63,9 | 63,9 | 68   | 69   | 64,6 |
| On return - Over (2)            | dB (A) | 70   | 65,7 | 64,7 | 65,7 | 65,8 | 64,8 | 68,6 | 67,6 | 68,7 |
| On the front - Over (3)         | dB (A) | 52   | 48,4 | 48,3 | 48,1 | 48,2 | 48,1 | 50,7 | 50,6 | 50,8 |

1. Noise pressure level at 1 meter in free field – ISO 3744
2. Air intake from the front
3. Air intake from the bottom

## ELECTRIC DATA

Electrical data of the system at full load working conditions.

| Version                     |         | U/O      | U/O      | U/O      | U/O      | U/O      | U/O      | U/O      | U/O      | U/O      | U/O      |
|-----------------------------|---------|----------|----------|----------|----------|----------|----------|----------|----------|----------|----------|
| Model                       |         | 29       | 40       | 51       | 52       | 67       | 76       | 78       | 90       | 108      | 140      |
| Frame                       |         | M        | M        | M        | L        | L        | L        | XL       | XL       | XL       | XL       |
| Power supply                | V/ph/Hz | 400/3/50 | 400/3/50 | 400/3/50 | 400/3/50 | 400/3/50 | 400/3/50 | 400/3/50 | 400/3/50 | 400/3/50 | 400/3/50 |
| Maximum current input (FLA) | A       | 30,6     | 41,5     | 41,5     | 47       | 57,4     | 57,4     | 82       | 82       | 108      | 108      |

1. U = Under, Downflop / O = Over, Upflow

### **WARNING:**

The electric data indicated refer only to the indoor unit.

Optional accessory electric data are included within the dedicated chapters and must be added.

Please refer to ELCA WORLD selection program to calculate the electrical data of the air conditioner according to the requested optional ACCESSORIES.

The remote air-cooled condenser is not included because it has independent power supply.

MICROPROCESSOR CONTROL SYSTEM



Controller

The unit is equipped with the controller connected to a 6 keys keyboard with graphic display on which all information in English language or easily identifiable symbols are displayed.

The controller disposes of a “flash” memory that preserves the information even in absence of power supply. Part of memory is dedicated to the registration of intervened events - up to 200 events.

The system can manage up to 4 T/H probes on air intake, 4 T/H probes on air delivery, 4 remote T/H probes and a T/H probe for outdoor air.



Keyboard and Display

DISPLAY – KEYBOARD FUNCTIONS

|  |            |  |
|--|------------|--|
|  | ALARM      | Alarm presence with red light.<br>Push for alarm description.<br>In case of more alarms scroll by UP / DOWN.                 |
|  | PRG        | Menu list, scrolled by UP/DOWN:<br><b>Unit; Set-point; In/Out; Clock; History; User; Service; Factory.</b> ENTER to execute. |
|  | ESC        | Home. Used to come back to the previous menu level or to the main screen.  |
|  | UP<br>DOWN | Changes pages and values of sets.<br>By pressing in HOME mask, the synoptic of the main controls is displayed.               |
|  | ENTER      | Moving the cursor on adjustable Program(s) fields to confirm the changes.<br>Press ENTER to get out the fields.              |

DISPLAY – MAIN MASK

|         |        |         |        |        |        |        |         |    |   |    |
|---------|--------|---------|--------|--------|--------|--------|---------|----|---|----|
| area 11 | area 1 | area 12 | HH     | :      | MM     | DD     | /       | MM | / | YY |
|         | area 2 |         | -      | 9      | 9      | .      | 9       | °C |   |    |
|         | area 3 |         | -      | 9      | 9      | .      | 9       | %  |   |    |
|         | area 4 | area 5  | area 6 | area 7 | area 8 | area 9 | area 10 |    |   |    |
|         |        |         |        |        |        |        |         |    |   |    |



Touch 7" Display  
(accessory)

The main mask shows time, date, room temperature and humidity values (if the relative probe is present) and areas for displaying operating and alarm status with dedicated icons

- Area 1: Status of the unit: on / off
- Area 2: Status detail
- Area 3: Type of event (only in case of an event)
- Area 3\_A: Code and type of event
- Area 4: Active cooling devices
- Area 5: Active free-cooling devices
- Area 7: Active heating devices
- Area 8: on / off parameters
- Area 9: BMS address
- Area 10: LAN address
- Area 11: Schematic representation of units
- Area 12: Active function presence icon

## CONNECTIVITY

Through the optional serial port, the microprocessor control enables communication with the modern buildings BMS systems with the following protocols: MODBUS; LON; BACNET MS/TP RS485; BACNET OVER IP.

## PASSWORD

Level 1: On request of the End User. Allowing to reach USER menu

Level 2: Asks to Service: Allowing to reach SERVICE menu

Level 3: Asks to Service: Allowing to reach FACTORY menu

No passwords request to enter: UNIT, SETPOINT, IN/OUT, CLOCK, HISTORY menu

## GENERAL SCHEME

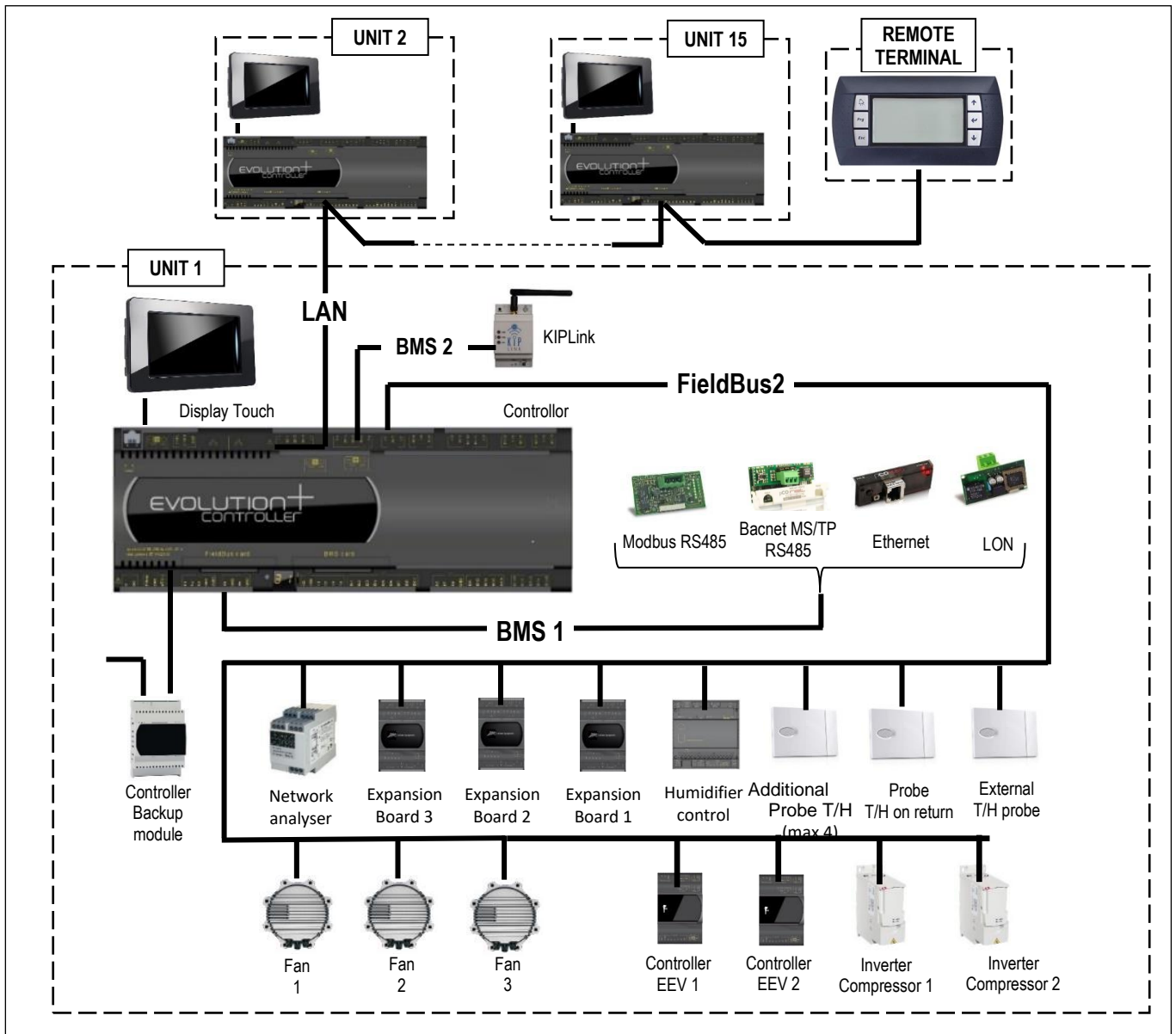

## LAN NETWORK

The LAN is part of the control software and it is possible to connect up to 15 units.

This type of connection allows to control the units in coherent way, moreover the units can be controlled and managed from a shared remote terminal.

## LAN ADDRESS LIST

| Unit n.                   | 1  | 2  | 3  | 4  | 5  | 6  | 7  | 8  | 9  | 10 | 11 | 12 | 13 | 14 | 15 | Remote Terminal |
|---------------------------|----|----|----|----|----|----|----|----|----|----|----|----|----|----|----|-----------------|
| Address Controller        | 1  | 2  | 3  | 4  | 5  | 6  | 7  | 8  | 9  | 10 | 11 | 12 | 13 | 14 | 15 | ---             |
| Display & Keyboard adress | 16 | 17 | 18 | 19 | 20 | 21 | 22 | 23 | 24 | 25 | 26 | 27 | 28 | 29 | 30 | 32              |

The unit connection to the local network (LAN) allows to perform the following functions:

- Balancing the operating hours among the different units by rotating the reserve units.
- Turning on the reserve units in case other units should turn off due to an alarm, maintenance or power feed interruption.
- Turning on reserve units to offset the excessive thermal load.
- Operating with all units based on the average temperature and humidity values read by the temperature probes only in the operating units.
- DYNAMIC MASTER function that makes the role of the Master unit dynamic. In case of alarm, shutdown, maintenance, power failure, etc. on the Master unit, the function automatically elects a new Master unit.

## UNIT FIXING BRACKET

The bracket is supplied as an assembly kit, with bolts for fixing it to the unit.

It is a safety device that must be installed together with the unit and fixed to a structural part at the installation site (wall, structure, etc.) to avoid the risk of the unit toppling over due to external causes (accidental impacts, earthquakes, etc.).

Wall fixing screws are not supplied.

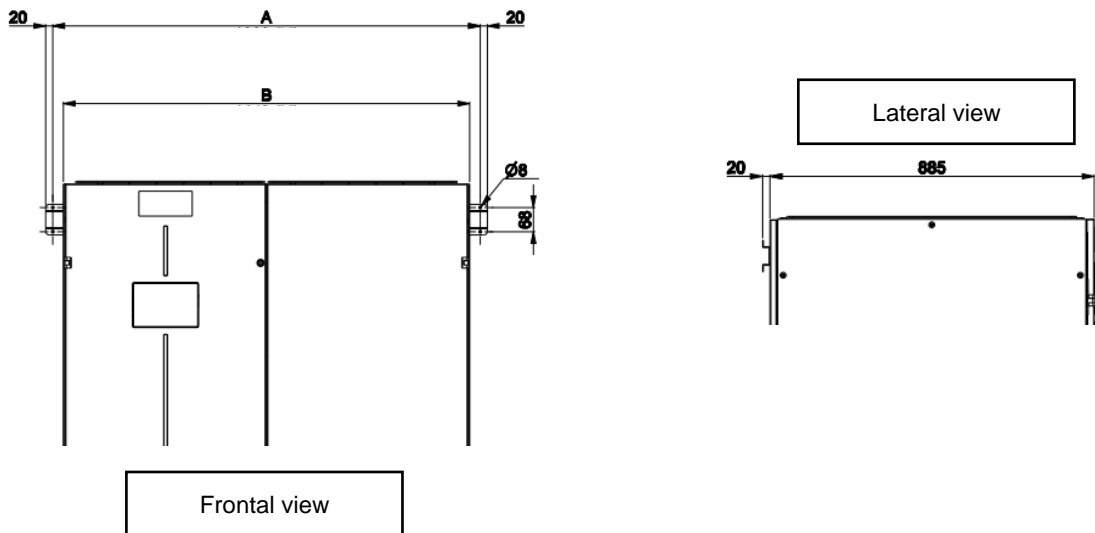

| Frame       |    | M    | L    | XL   |
|-------------|----|------|------|------|
| Dimension A | mm | 1202 | 1660 | 2610 |
| Dimension B | mm | 1142 | 1600 | 2550 |

|                                 |  |
|---------------------------------|--|
| B263.....                       | Mandata over - rip. Inferiore  |
| B266.....                       | Mandata front. - rip. Alto   |
| B681.....                       | Chiusura basamento. Pannello di chiusura per isolamento acustico del basamento dell'unità in versione OVER.  |
| B670.....                       | Senza griglia protez superiore   |
| B691.....                       | Kit bassa temperatura  |
| B692.....                       | Kit b.t.+ricevitore aggiuntivo   |
| B693.....                       | Ricevitore aggiuntivo  |
| 601 .....                       | Valv. Solenoide linea liquido  |
| A547.....                       | Portata costante. Sistema automatico di regolazione della portata aria nel corridoio. Il sistema controlla la velocità di rotazione dei ventilatori in modo da tenere costante la portata dell'aria tramite un trasmettitore di pressione differenziale collegato al controllo a microprocessore.        |
| A548.....                       | Prevalenza costante. Sistema automatico di regolazione della pressione aria nel corridoio. Il sistema controlla la velocità di rotazione dei ventilatori in modo da tenere costante la pressione dell'aria tramite un trasmettitore di pressione differenziale collegato al controllo a microprocessore. |
| B951.....                       | Aliment. Condensatore monofase   |
| B952.....                       | Aliment. Condensatore trifase  |
| 383 .....                       | Cavi numerati + colorazione per UK   |
| P181 .....                      | Analizzatore di rete (macchina standard) Strumento multifunzione per il calcolo e la visualizzazione delle misure elettriche della macchina  |
| P111 / P113 .....               | Doppia alimentazione elettrica. Sistema per doppia alimentazione elettrica con change-over automatico.   |
| .....                           | P111 - doppia alimentazione  |
| .....                           | P113 - KIT doppia alimentazione. Fornito in kit di montaggio   |
| 4181 / 4182 / 4184 / 4185 ..... | Schede seriali:  |
| .....                           | 4181 – Scheda protocollo MODBUS;   |
| .....                           | 4182 – Scheda protocollo LON;  |
| .....                           | 4184 – Scheda BACNET MS/TP RS485;  |
| .....                           | 4185 – Scheda BACNET OVER IP.  |
| 6461 .....                      | HPC  |
| 1441 .....                      | KIPlink + TASTIERA COMPACT   |
| 1442 .....                      | KIPlink+TOUCH SCREEN 7 POLLICI   |
| 6195 .....                      | TOUCH SCREEN 7 POLLICI   |
| 6196 .....                      | KIPlink  |
| C9261063.....                   | Remote Display   |
| P151 .....                      | Display ribassato per UNDER – solo macchine UNDER equipaggiate con plenum sotto l'unità.   |
| A492.....                       | Sensore allagamento + rilevatore addizionale. Fornito in kit di montaggio  |
| A511.....                       | Sensore fumo. Fornito in kit di montaggio.   |
| A521.....                       | Sensore fuoco. Fornito in kit di montaggio.  |
| B811.....                       | Sensore flusso aria  |
| 4503 .....                      | Fast restart (ultracap)  |
| 2412 .....                      | Ctr. seq. fasi+controllo tens  |
| A381.....                       | Pompa scarico condensa. Fornita in kit di montaggio. Il kit comprende pompa con galleggiante di attivazione e 10m lineari di tubazione per lo scarico.   |
| A812 (2) .....                  | Free-cooling diretto. Gestione free-cooling diretto.   |
| A791.....                       | Controllo temperatura su aria aspirazione.   |
| A431.....                       | Resistenze elettriche. Riscaldamento con resistenze elettriche.  |
| B803.....                       | VALVOLA 3 VIE 0/10V  |
| B807.....                       | VALVOLA 2 VIE EPIV   |
| P051 (4) .....                  | Funzione deumidificazione.   |
| 4303 / 4305 (5).....            | Humidification: Modulating steam humidifier with immersed electrodes and electronic control.   |
| .....                           | 4303 - humidifier vap. 8kg/h   |
| .....                           | 4305 - humidifier vap. 15kg/h  |

|                           |   |
|---------------------------|---|
| P161 .....                | Air suction probe T/rH. Combined temperature / humidity probe on air intake. The accessory replaces the temperature probe installed on the air intake in the indoor unit. |
| P071 / P072 / P073 / P074 | Sonda T/RH remota. Combined Temperature / Ambient Humidity Probe. For remote installation, in addition to the combined probe on the machine air intake.                   |
| P101 .....                | EARTHQUAKE ANCHOR KIT   |
| P084 .....                | Air filter ePM10 50%. Highly efficient regenerable air filter (secondo ISO EN 16890).   |
| B961-B971 .....           | PL. EMPTY   |
| B962-B972 .....           | PL. EMPTY + INSULATION  |
| B963-B973 .....           | PL. EMPTY + DAMPER  |
| B964-B974 .....           | PL. EMPTY INSULATION+DAMPER   |
| B965-B975 .....           | PL. 1 GRILLE  |
| B966-B976 .....           | PL. 1 GRILLE INSULATION   |
| B967-B977 .....           | PL. 1 GRILLE + DAMPER   |
| B968-B978 .....           | PL. 1 GRILLE INSULATION +DAMPER   |
| B969-B979 .....           | PL. 3 GRILLES   |
| B96A-B97A .....           | PL. 3 GRILLES INSULATION  |
| B96B-B97B .....           | PL. 3 GRILLES + DAMPER  |
| B96C-B97C .....           | PL. 3 GRILLES INSULATION +DAMPER  |
| B96D .....                | PL. FILTER ePM1 50%   |
| B96E .....                | PL. FILTER ePM1 50%+DAMPER  |
| B96F .....                | PL. SILENCED  |
| B96G .....                | PL. SILENCED+DAMPER   |
| B96H .....                | PL. SILENCED+1 GRILLE   |
| B96I .....                | PL. SILENCED+1 GRILLE+DAMPER  |
| B97D .....                | PL. FILTER COARSE 60% TASCA   |
| B97E .....                | PL. FILT COARSE 60% TASCA+DAMPER  |
| B97F .....                | PL. FILTER COARSE 60%   |
| B97G .....                | PL. FILTER COARSE 60%+GRILLE - N.A.   |
| B97H .....                | PL. FREE-COOLING  |
| A531 (6) .....            | DAMPER on-off. The non-return damper is contained in a frame installed on the air supply of the machine.  |
| B981 .....                | SUPPORTING FRAME H255-450MM   |
| B982 .....                | SUPPORTING FRAME H450-750MM   |
| B983 .....                | SUPPORTING FRAME H750-1000MM  |
| B991 .....                | INSULATION INSULATION   |
| 9969 .....                | NYLON PACKAGING, WOODEN CAGE  |
| 9976 .....                | PALLET AND NYLON PACKING  |

## MANDATORY COMBINATIONS OF ACCESSORIES

1. The presence of the "6461 - HPC software enabling" accessory requires the presence of the "1441 - Kiplink + COMPACT KEYBOARD" accessory
2. The presence of the accessory "B97H - PL. FREE-COOLING" requires obligatorily the presence of accessory "A812 - Direct free cooling management".
3. The presence of accessory "P051 - Dehumidification function" obligatorily requires the presence of accessory "P161 Air intake T/rH probe".
4. The presence of the "A812 Direct free-cooling management" accessory obligatorily requires the presence of the "P161 T/rH probe air intake" accessory
5. The presence of ACCESSORIES "4303 / 4305 Vapour humidifier" requires obligatory presence of accessory "P161 T/rH probe air intake".
6. The presence of the accessory "A531 On-off damper" requires obligatorily the presence of the accessory "9969 Wood cage packing".



## OPTIONAL ACCESSORIES: B263 - OVER AIR DELIVERY – BOTTOM INTAKE

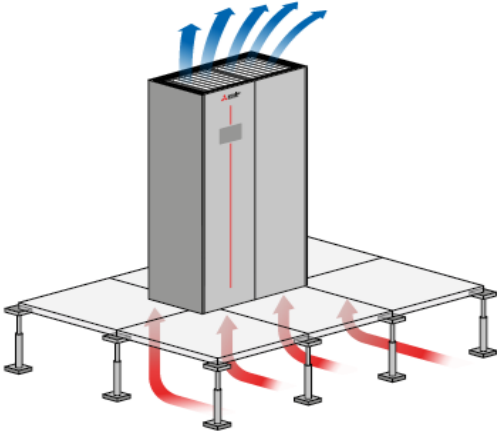

Available for **OVER** units.

Thanks to the special design of the base, it is possible to provide air intake from the bottom of the unit. The air flow rate is the nominal one.

The accessory provides for blind front panelling and is incompatible with the unit's internal filters.

P083 AIR FILTER COARSE 60%

P084 AIR FILTER ePM10 50%

It is necessary to provide filtering of the air entering the machine. In the case of combination with a plenum with filters, it is necessary to guarantee access to the filters for cleaning and replacement operations.

## OPTIONAL ACCESSORIES: B266 - FRONT. AIR DELIVERY – TOP INTAKE

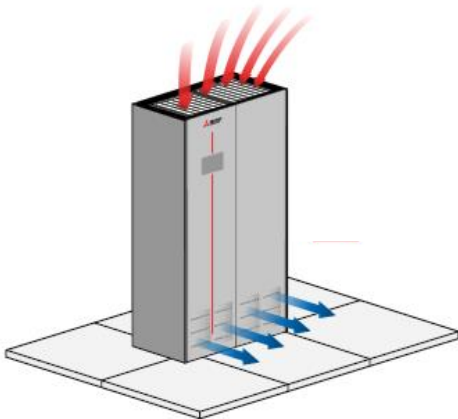

Available for **UNDER** versions, the accessory provides a grille to front panel to ensure front air delivery, we recommend the combination with a plenum with grille to improve system performance.

The accessory is suitable for application in server rooms where it is not possible to provide a raised floor or ducting of the air supply, where there are server racks with ventilated front and rear doors.

The typical installation is of the perimeter type, the units are positioned along the walls of the room, the units draw in air from the top and send it horizontally into the cold aisle for cooling the racks. Warm air is expelled from the racks at the top or from the back.

## OPTIONAL ACCESSORIES: B680 - CLOSING BASEMENT

Available for the OVER version with FRONTAL RECOVERY or UNDER version with accessory B266 "FRONTAL RECOVERY - HIGH RECOVERY", the accessory provides a panel to close the base of the unit, which prevents the flow of air in the lower part of the machine.

OPTIONAL ACCESSORIES: B691 - OUTDOOR LOW TEMPERATURE KIT

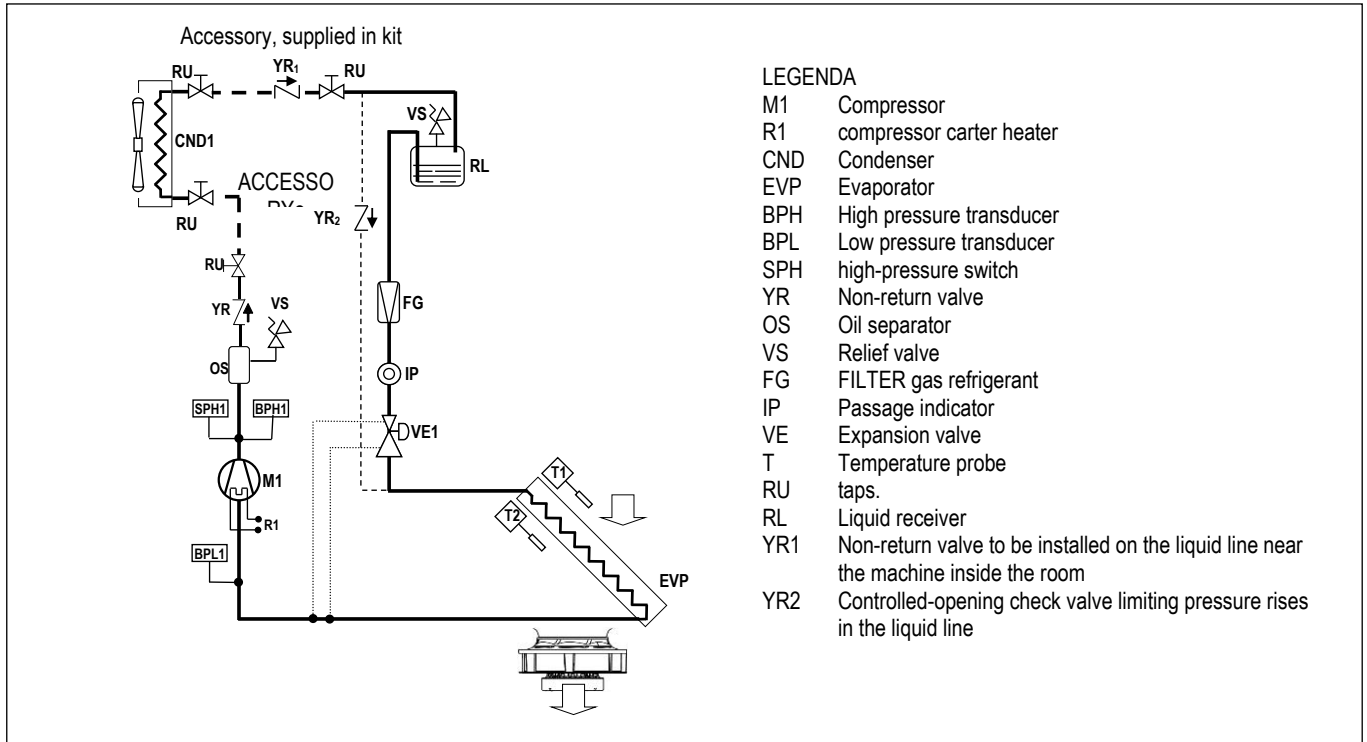

The system is necessary to ensure correct start-up and operation of the unit at very low outside air temperatures: between -20°C and -40°C. (The minimum attainable temperature depends on the remote condenser combined, with AC fans (-40°) or EC fans (-35°))

The accessory provides, for each refrigerant circuit

- A check valve (YR1), supplied in kit form, to be installed inside the room in the vicinity of the machine, on the liquid line exiting the external remote condenser. It prevents the migration of refrigerant in its liquid state to the condenser in conditions of low outside air temperature.
- A check valve (YR2) with controlled opening, factory installed on the machine. Limits any pressure rise in the section of the liquid line between the expansion valve and the check valve (YR1).

OPTIONAL ACCESSORIES: B693 - ADDITIONAL RECEIVER

In those installations with equivalent lengths of refrigerant lines of more than 25 m, the installation of an additional liquid receiver is recommended, to be installed on the liquid line outside the unit

OPTIONAL ACCESSORIES: B692 - L.T KIT + ADDITIONAL RECEIVER

An additional liquid receiver can be requested in addition to the low temperature kit to be installed on the liquid line outside the unit (see recommended minimum volumes in the table below)

MINIMUM RECOMMENDED VOLUME TABLE:

|                                   |       | 29  | 40 | 51 | 52  | 67 | 76 | 78    | 90    | 108   | 140   |
|-----------------------------------|-------|-----|----|----|-----|----|----|-------|-------|-------|-------|
|                                   | MODEL | M   | M  | M  | L   | L  | L  | XL    | XL    | XL    | XL    |
| Additional liquid receiver volume | l     | 4,8 | 6  | 6  | 4,8 | 8  | 8  | 2 x 6 | 2 x 6 | 2 x 8 | 2 x 8 |

Liquid receivers are supplied with safety valve

## OPTIONAL ACCESSORIES: 601 - SOLENOID VALVE ON LIQUID LINE



The accessory has the function of closing the liquid line, in the event of the machine stopping or blackout, avoiding the risk of liquid refrigerant migration into the evaporator.

Recommended accessory for:

- Refrigerating lines greater than 10m in equivalent length.
- Machines equipped with electronic expansion valve.

## OPTIONAL ACCESSORIES: A547 – COSTANT AIR FLOW

The accessory provides for the installation of a differential pressure transducer which allows the fan speed to be regulated guaranteeing the flow rate set-point that can be set by the controller, within the limits established by the manufacturer. With the intervention of the functions that require modulation of the fan flow rate (humidification, dehumidification, heating with electric heaters) the constant flow rate control is temporarily deactivated to leave room for regulation.

## OPTIONAL ACCESSORIES: A548 - PREVALENZA COSTANTE



The optional is a differential pressure sensor with a 0...20mA output signal. The device is installed in the machine.

The system controls the air pressure in the raised floor (Under version) or in the duct (Over version). Through the relief piping of the room pressure (low pressure side) and the air supply of the fan (high pressure side) the fan rotation speed is controlled to keep the air pressure constant.

Pressure control range from 0 to 100 Pa.

## OPTIONAL ACCESSORIES: B792 – POWER SUPPLY 400/3+N/50

## OPTIONAL ACCESSORIES: B796 – POWER SUPPLY 380/3+N/60

## OPTIONAL ACCESSORIES: B796B - POWER SUPPLY 380/3/60

## OPTIONAL ACCESSORIES: B796 - POWER SUPPLY 380/3+N/60

## OPTIONAL ACCESSORIES: B798 - POWER SUPPLY 460/3+N/60

## OPTIONAL ACCESSORIES B951 – REMOTE CONDENSER POWER SUPPLY SINGLE-PHASE

The accessory allows a single-phase remote condenser to be supplied directly from the indoor machine. The electrical panel of the indoor machine is prepared with the electrical protection components and terminal board for the electrical connection to the capacitor. The accessory is not compatible with power supplies without a neutral.

## OPTIONAL ACCESSORIES B952 - REMOTE CONDENSER POWER SUPPLY THREE-PHASE

The accessory allows a three-phase remote condenser to be supplied directly from the indoor machine. The electrical panel of the indoor machine is prepared with the electrical protection components and terminal board for the electrical connection to the capacitor.

## OPTIONAL ACCESSORIES 383 – NUMBERED WIRINGS + UK REQUESTS

The machine's electrical cables are all numbered for easy identification. For the power section it is possible to change the colour for the UK market:

| CABLE        | 383 - COLOUR FOR UK |
|--------------|---------------------|
| EARTH        | YELLOW / GREEN      |
| NEUTRAL      | BLUE SKY            |
| PHASE 1 (L1) | BROWN               |
| PHASE 2 (L2) | BLACK               |
| PHASE 3 (L3) | GREY                |
| PHASE        | RED                 |

## OPTIONAL ACCESSORIES: P181 - CON ANALIZZATORE DI RETE



This device provides continuous measurement of power consumption, monitoring current, voltage and power. These values are sent to unit microprocessor via RS485 serial cable, as shown on the unit wiring diagram.

The displayed variables are:

- Phase to phase voltage, only for three-phase units;
- Phase voltage (phase-neutral);
- Phase current;
- Neutral current only for three-phase units;
- Active phase power, only for three-phase units;
- Total active power;
- Active energy;
- Hour counts



### INTERNAL INSTALLATION

The optional is installed within the electrical box downstream the main switch with door safety lock and includes:

- Network transducer;
- Current transformers, one for each power supply phase cable.

## OPTIONAL ACCESSORIES: P111 – DUAL POWER SUPPLY



The accessory requires a mandatory neutral supply.

The accessory is not available for voltages 460/3/60 and 460/3+N/60.

The ATS system constantly monitors the power line and switches in the event of voltage anomalies or a phase failure.

The system can be set up with 2 operating logics:

1. Line 1 priority:

In the event of a fault on line I, the system switches to line II; once the fault on line 1 has been resolved, the system switches back to the priority line.

2. No priority line.

In the event of a fault on line I the system swaps over to line II, the return to line I only takes place in the event of a fault on line II

Manual operation is also possible by inserting the handle into the ATS.

For continuous operation of the unit, the combination of the dual power supply with the fast restart system is recommended: in the event of a power failure, the fast restart system keeps the microprocessor powered for a few minutes, preventing it from restarting.

The remote capacitor must be powered by the automatic switch. We recommend the accessory: "P191 Remote condenser power supply" from the electrical panel of the indoor unit".

If accessory "P181 Mains analyser" is selected, it is not possible to select accessory P111 Dual power supply, but only "P113 Dual power supply kit".

## OPTIONAL ACCESSORIES: P113 - KIT DUAL POWER SUPPLY

The 'P113 - DOUBLE POWER SUPPLY KIT' accessory is supplied as a kit with an IP3X-rated containment box.

## OPTIONAL ACCESSORIES: 4180 - WITHOUT PROVISION FOR REMOTE CONNECTIVITY

## OPTIONAL ACCESSORIES: 4181 - MODBUS PROTOCOL SERIAL CARD



The board is installed at the factory.  
The serial board allows the ModBus communication protocol to be used via the RS485 3-wire physical connection.

## OPTIONAL ACCESSORIES: 4182 - LON PROTOCOL SERIAL CARD



The board is installed at the factory. The serial board allows the LonWorks communication protocol to be used via the FTT-10 physical connection. The manufacturer provides the serial card and the .NXE and .XIF files necessary for LonWorks engineers to configure the network. The board is programmed by the technician in charge of integration.  
For all technical information, refer to the Interface Manual

## OPTIONAL ACCESSORIES: 4184 - BACNET MS/TP RS485 SERIAL CARD



The board is installed at the factory. The serial board allows the BACnet MS/TP communication protocol to be used via the 3-wire RS 485 physical connection.  
For all technical information, please refer to the Interface Manual.

## OPTIONAL ACCESSORIES: 4185 - BACNET OVER IP SERIAL CARD



The board is installed at the factory.  
The serial board allows the use of BACnet IP, Modbus TCP/IP and SNMP communication protocols via the physical Ethernet standard. The supervision network is realised by the technicians who develop the BACnet interfacing. The interfacing database is that for the Modbus protocol. The manufacturer will supply the boards and the .MIB file necessary for the technicians to configure the network.  
The programming of the board is the responsibility of the integrator.  
Please refer to the Interfacing Manual for all technical information and what is necessary to connect to the Internet for displaying and modifying variables. The board is installed at the factory.  
The serial board allows the use of BACnet IP, Modbus TCP/IP and SNMP communication protocols via the physical Ethernet standard. The supervision network is realised by the technicians who develop the BACnet interfacing. The interfacing database is that for the Modbus protocol. The manufacturer will supply the boards and the .MIB file necessary for the technicians to configure the network.  
The programming of the board is the responsibility of the integrator.  
Please refer to the Interfacing Manual for all technical information and what is necessary to connect to the Internet for displaying and modifying variables.

## OPTIONAL ACCESSORIES: 6461 - HPC (ONLY DF VERSION)

# HPC

Hydronic Plant Connect

HPC is the new advanced and fully integrated control function designed by MEHITS for hydronic plant optimization. It connects MEHITS chillers and indoor CRAH units without any external devices.

### INFRASTRUCTURE

The HPC function is based on LAN groups and the KIPLink network (KIPLAN).

- Every indoor and outdoor unit must be equipped with KIPLink.
  - Every outdoor unit must be equipped with Multi Manager.
  - HPC supports up to 20 LAN groups of indoor air conditioners (max 15 units per group) and 1 LAN group of outdoor chillers (max 8 units).
  - HPC requires a KIPLAN (KIPLink network) made up of one unit per each LAN group.
  - The result is a KIPLAN made of 1 chiller unit (KIP Master), and up to 20 indoor units (KIP Clients).
  - KIPLAN network allows HPC data communication between the different LAN groups (indoor and outdoor).
  - KIPLink allows direct access to all HPC variables and parameters with devoted menus and pages.
- The most important parameters are also available on the Compact/Large Keyboard.

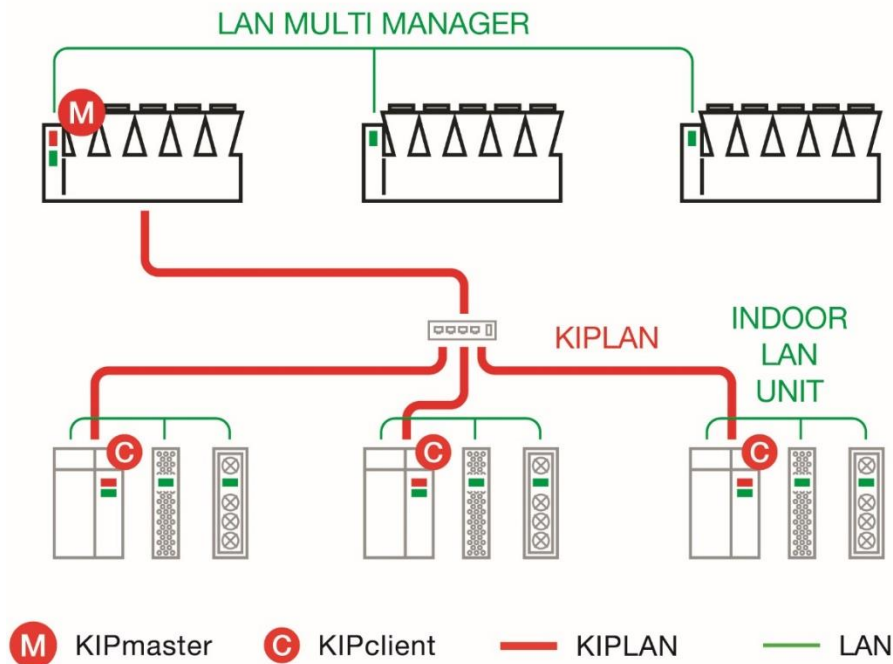

Further information is available in the dedicated Manuals (W3000+, Evolution+, KIPLink).

### WORKING LOGICS

The HPC control logics enhance the system efficiency leveraging on partial loads, redundant units, and favourable ambient conditions.

HPC acts on time intervals. The time lapse between each HPC action can be set from 1 to 500 minutes. The time left until the AV action is visible in the KIPLink group interface section.

According to the instantaneous operating conditions detected in the chilled water system, HPC regulates: the chillers' set-point, the pumps' speed, and the indoor air conditioners' valves and fans.

**The main variables taken into consideration are:**

- Cooling demand of each indoor unit group (room temperature, fans' speed, valve opening)
- Chilled water temperature
- Pumps' speed
- Chillers' group operating status (outdoor air temperature, FC availability)

The highest benefits are achieved in systems with VSD pumps and free-cooling chillers.

IT cooling load satisfaction is paramount. HPC always gives priority to room cooling dependability. Therefore, actions are taken on the basis of the indoor unit groups' status.

There are 4 operating modes, in order of priority:

**1. Reset**

When the cooling demand of at least one group of indoor units suddenly increases. HPC contribution is reset and suspended until the Reset message is active. The system immediately increases the cooling capacity.

**2. Reduce**

When the cooling demand of at least one group of indoor units slightly increases. HPC contribution is reduced. The system increases the cooling capacity.

**3. Optimization On**

When the cooling demand of all groups of indoor units remains stable or decreases. HPC optimizes the system by increasing its contribution.

**4. No Action**

When the cooling demand of all groups of indoor units remains stable or decreases, but HPC has already pushed the system to the best performance achievable in the current conditions. No further action is taken.

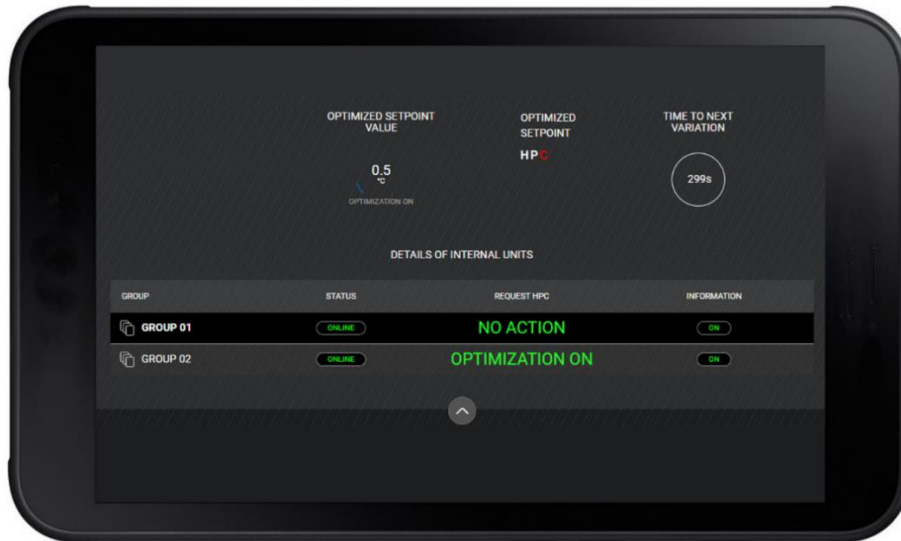

**PLUS**

- Fully in house developed and patent pending
- Completely integrated, no need for any external devices
- Based on proprietary logics and devices (Multi Manager, KIPlink)
- Energy simulations, comparisons, and payback analysis available on ELCA software
- Ideal to complete the package of a MEHITS chilled water system (chillers and CRAHs)



- OPTIONAL ACCESSORIES: 1441 - CONTROL UNIT VIA KIPLINK + COMPACT KEYBOARD**
- OPTIONAL ACCESSORIES: 1442 - CONTROL UNIT VIA KIPLINK + 7 INCH TOUCH SCREEN**
- OPTIONAL ACCESSORIES: 6192 - COMPACT KEYBOARD**
- OPTIONAL ACCESSORIES: 6196 - CONTROL UNIT VIA KIPLINK**

The optional is factory installed.  
KIPLink is an innovative system based on Wi-Fi technology that allows to operate on a unit directly from Smartphone or Tablet via an APP. The optional is factory installed.



### WI-FI MODULE

- Standard: IEEE 802.11n - 802.11g
- Frequencies: 2.4 - 2.4835 GHz
- Output power: <20 dBm (equivalent to <100mW)
- Safety: WPA2
- Flow: < 20m

### APP MEHITS

Operating System: Android 5® or higher, IOS 8® or higher, Windows 10® or higher  
Download: Google Play®, Apple Store® and Microsoft Store®.

### HOW TO USE KIPLINK

KIPLink can be used in three ways:

#### Proximity keyboard:

Approaching the machine with a Smartphone or a Tablet with the MEHITS APP installed, you can connect to the unit via Wi-Fi and you can control it as you would from the standard controller keyboard. It is possible to switch the unit on and off, change the sets and reset alarms. Knowing the relative passwords, you access the parameters of the USER, SERVICE and MANUFACTURER menus.

#### Local Monitoring:

Using a Smartphone, a Tablet or PC connected to the LAN of the building where the unit is also connected. Access is via WEB via a browser. The system has two access profiles: ONLY READ and READ & WRITE.

ONLY READ allows only the visualization of the parameters and it is not possible to control the unit.

READ & WRITE allows you to switch the unit on and off, change the sets and reset alarms. Knowing the relative passwords, you access the parameters of the USER, SERVICE and MANUFACTURER menus.

#### Remote monitoring:

You can use a Smartphone, Tablet or PC connected to the VPN of the building where the unit is also connected to monitor the unit from any geographical location where there is an internet connection. Use a secure

VPN to avoid access by third parties who could compromise operation of the unit. The user is responsible for ensuring a secure connection.



### STORING DATA

The system can store some data on a 1GB MicroSD card to be installed on the device. The data can be used for Service diagnostics. The card is not provided.

### KIPLINK NETWORK

It is possible to set up mixed networks consisting of several KIPLink devices (10 maximum), to display information from different devices (called Client KIPLink) on one single device (called Master KIPLink).

The information is collected from the various Client KIPLink devices connected to EVOLUTION+ / W3000 TE/ CX-4 controllers and sent through the Wi-Fi or Ethernet network to the Master KIPLink device, which stores them and makes them available through an appropriate user interface. The connection with the Master KIPLink can take place via Wi-Fi, via Ethernet or a combination of the two. For complete information on the KIPLink system, please consult the relative technical documentation.



## OPTIONAL ACCESSORIES: 6195 - COMPACT 7 INCH TOUCH SCREEN

The optional is factory installed.

7" touch-screen graphic display with 16.7 million colors for the management and monitoring of operating and alarm status.

The Display is equipped with a MicroUSB 2.0 port for the service connection.

The navigation bars are always present on the display to allow quick and intuitive navigation..

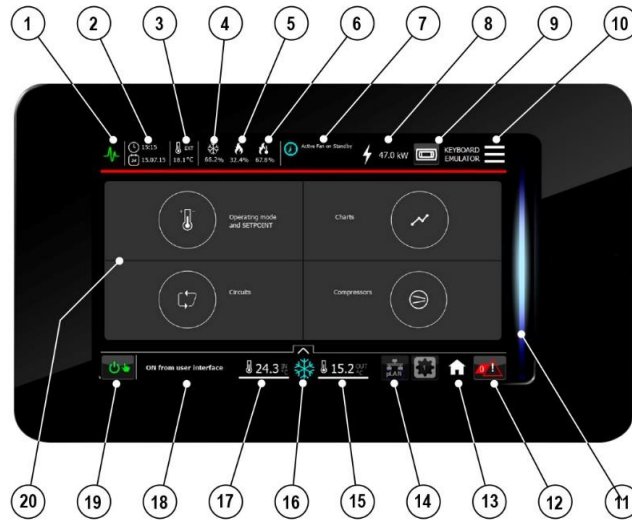

### TOP NAVIGATION BAR

1. Status of connection with the controller. Green: connection OK; Red: connection Error
2. Time and date
3. External temperature value by dedicated probe
4. Active percentage of Cooling
5. Active percentage of Heating
6. Active percentage of Post-Heating
7. Unit active functions
8. Power meter readings
9. PGD1 keyboard emulator
10. Rapid access to the menu (Quick menu)

### BOTTOM NAVIGATION BAR

11. Light bar for machine status identification
12. Alarm button to access the alarm management screen and the number of active alarms
13. Home button for returning to the Homepage
14. pLAN network
15. Temperature of outlet air or percentage of humidity.
16. Operating mode button.
17. Inlet air temperature
18. Unit status
19. On/Off button

### DISPLAY AREA

20. Main menu a. Operating mode and Set-Point
- b. Circuits
- c. Charts
- d. Compressors

For complete information on Graphic Display system, please consult the relative technical documentation.

## OPTIONAL ACCESSORIES: C9261063 – REMOTE DISPLAY



The display is supplied but not installed at the factory. If a group of units is connected via LAN (UP TO 15), it is possible to view all the parameters of each individual unit via a single display. The display kit consists of:

- a PGD physical keyboard
- a 1 m cable
- a T shunt card

## OPTIONAL ACCESSORIES: P151 – LOWERED DISPLAY FOR UNDER

The accessory is recommended for UNDER units when the plenum on the air supply is provided. The display/keyboard located on the front panel of the machine is installed lowered by 51 cm to facilitate its consultation and use. The accessory is not compatible with touch displays.

## OPTIONAL ACCESSORIES: A491 - WATER LEAKAGE DETECTOR

## OPTIONAL ACCESSORIES: A492 - WATER LEAKAGE DETECTOR + ADDITIONAL DETECTOR



The system includes an electronic relay installed in the electrical panel of the indoor machine and 2 water detectors to be connected in series. The electrical connections for the probe and the alarm contact are present in the indoor machine's terminal board. The sensors are supplied to be connected and installed at customer care.

## OPTIONAL ACCESSORIES: A511 - SMOKE DETECTORS

Is possible to install one or both of the following sensors. Sensors are supplied in mounting kit. Installation within the room at customer care.



The device is supplied in mounting kit. The optical smoke detector senses the presence of combustion by-products (visible smoke) and activates an alarm. The operating principle is based on the light scattering technique (Tyndall effect). The device is in conformity to EN 54-7 standard. Technical features:

|                       |                   |                     |                     |
|-----------------------|-------------------|---------------------|---------------------|
| Material              | ABS               | Relative humidity   | <93% not-condensing |
| Power supply          | 12...28 Vdc       | Index of protection | IP 20               |
| Normal current        | 50µA 24 Vdc       | Testing by magnet   | Yes                 |
| Alarm current         | 25mA 24 Vdc       | Relay               | max. 1A 30Vdc       |
| LED visibility        | 360° (double led) | Signal repeater     | 14mA 24 Vdc         |
| Storage temperature   | -10...+70°C       | Covered area        | 40m2 max.           |
| Operating temperature | -10...+70°C       | Shielded connection | Min. 0.5 mm2        |
| Max. speed air        | 0.2 m/s           | Colour              | White               |

Supplied with unit to be connected and installed at customer care close to the unit.

## OPTIONAL ACCESSORIES A521 – FIRE DETECTOR



The device is supplied in mounting kit. The fire detector has been designed to identify temperatures at which fires may start. When the temperature exceeds the set threshold or when there is a rapid variation in temperature, the relay is activated to signal an alarm. The device is in conformity to EN 54-5 standard.

Technical features:

|                       |                     |                             |               |
|-----------------------|---------------------|-----------------------------|---------------|
| Material              | ABS                 | Index of protection         | IP 20         |
| Power supply          | 12...28 Vdc         | Testing by magnet           | Yes           |
| Normal current        | 50µA 24 Vdc         | Relay                       | max. 1A 30Vdc |
| Alarm current         | 25mA 24 Vdc         | Signal repeater             | 14mA - 24 Vdc |
| LED visibility        | 360° (double LED)   | Alarm temperature threshold | 62°C          |
| Storage temperature   | -10...+70°C         | Covered area                | 40m2 max.     |
| Operating temperature | -10...+70°C         | Shielded connection cable   | Min. 0.5 mm2  |
| Relative humidity     | <93% non-condensing | Colour                      | White         |

Supplied with unit to be connected and installed at customer care close to the unit.

## OPTIONAL ACCESSORIES B811 – AIR FLOW SENSOR



The system includes a differential pressure switch installed in the electrical cabinet or in the front compartment of the machine and the plastic piping for pressure measurement at the fan inlet.

Operating range: 0.2 ... 2.0 mbar (20 ... 200 Pa)

Tripping differential: 0.1 mbar (10 Pa)

Tripping value fixed at 0.2 mbar, cannot be changed.

## OPTIONAL ACCESSORIES 4503 - FAST RESTART (ULTRACAP )



The accessory is installed inside the unit's electrical panel.

In the event of brief blackouts or power surges, it keeps the unit's microprocessor powered for a few minutes and ensures the rapid resumption of machine operation when normal power supply conditions are restored.

## OPTIONAL ACCESSORIES 2412 - PHASE SEQUENCE CONTROL



The system monitors the correct sequence of the power supply phases and the status of the supply voltage, intervening in the event of undervoltage, overvoltage and incorrect phase rotation.

The accessory is installed in the electrical panel downstream from the main lockout switch and in the event of an alarm stops the unit's operation or prevents it from starting.

## OPTIONAL ACCESSORIES ACCESSORY: A381 – KIT CONDENSATE DRAIN PUMP

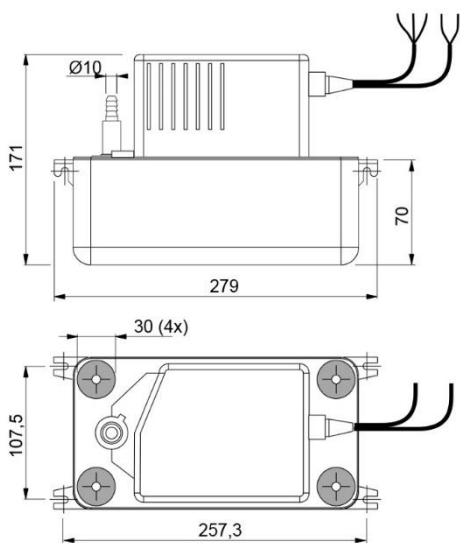

Water acidity: pH>2.5  
Tray volume: 2.0 l  
Protection IP 20

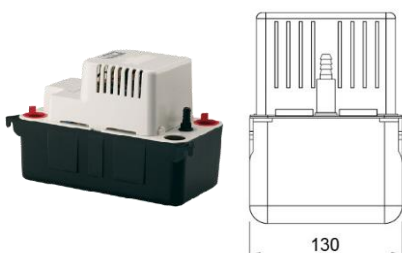

The accessory is supplied in kit form and involves the installation outside the machine of a condensate booster pump equipped with a tank with a microswitch float switch to activate the pump.

Together with the pump, 10 metres of anti-crushing spiral-type discharge pipe is supplied.

Operation of the pump is fully automatic, and any pump faults and overfilling can be seen by the controller.

The pump is suitable for the evacuation of humidifier discharge water, if fitted.

### WARNINGS

**Maximum delivery height: 5.0 m**

For all the machines the optional accessory is supplied in mounting kit.

### TECHNICAL DATA

Power supply: 230V~ 50Hz  
Electrical data: 70W – 0,67A  
Maximum water flow: 500 l/h  
Maximum delivery height: 5.0 m  
Sound level: 45dBA a 1 m  
Maximum water temperature: 70°C

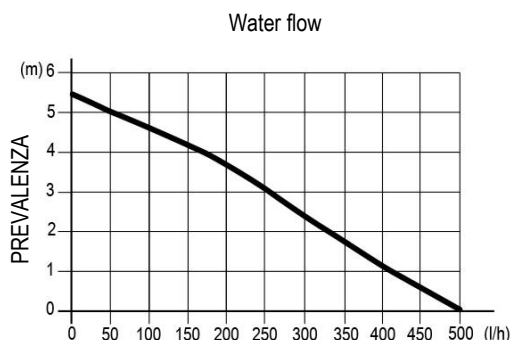

| Discharge head | Total length of discharge pipes (Ø 10 mm internal) |     |     |     |
|----------------|--|-----|-----|-----|
|                | 5m   | 10m | 20m | 30m |
| 1m             | 380  | 300 | 240 | 190 |
| 2m             | 310  | 260 | 200 | 150 |
| 3m             | 240  | 200 | 145 | 110 |
| 4m             | 150  | 130 | 80  | 60  |
| 5m             | 30   | 20  | 0   | 0   |

## OPTIONAL ACCESSORIES: A812 – WITH DIRECT FREE-COOLING

Preparation of the machine and control cabinet for direct free-cooling system, combination with "B97H - PLENUM FREE COOLING" accessory required.

## OPTIONAL ACCESSORIES: A791 - AIR TEMPERATURE CONTROL ON SUCTION AIR.

Machine set-up for room air temperature control with probes on air intake.

## OPTIONAL ACCESSORIES: A431 – ELECTRIC HEATERS

Electric heater consisting of finned aluminum elements, ensuring low surface temperature and deleting the air ionization problems. The optional is installed downstream the main cooling coil.

In electric heaters with three working steps the activation is binary type.

Components:

- Electric heater in aluminium armoured elements with integral fins
- Electrical control
- Safety thermostat.

Temperature control on suction air.

## TECHNICAL DATA

| AIR SUPPLY (1)          |    | U / O      | U / O      | U / O      | U / O       | U / O       |
|-------------------------|----|------------|------------|------------|-------------|-------------|
| <b>MODEL</b>            |    | <b>29</b>  | <b>40</b>  | <b>51</b>  | <b>52</b>   | <b>67</b>   |
| <b>FRAME</b>            |    | <b>M</b>   | <b>M</b>   | <b>M</b>   | <b>L</b>    | <b>L</b>    |
| <b>HEATING CAPACITY</b> |    | <b>6,8</b> | <b>6,8</b> | <b>6,8</b> | <b>13,5</b> | <b>13,5</b> |
| Absorbed current (OA)   | A  | 9,8        | 9,8        | 9,8        | 19,5        | 19,5        |
| First working step      | kW | 2,3        | 2,3        | 2,3        | 4,5         | 4,5         |
| Second working step     | kW | 4,5        | 4,5        | 4,5        | 9,0         | 9,0         |
| Third working step      | kW | 2,3 + 4,5  | 2,3 + 4,5  | 2,3 + 4,5  | 4,5 + 9,0   | 4,5 + 9,0   |

| AIR SUPPLY (1)          |    | U / O       | U / O      | U / O      | U          | U          |
|-------------------------|----|-------------|------------|------------|------------|------------|
| <b>MODEL</b>            |    | <b>76</b>   | <b>78</b>  | <b>90</b>  | <b>108</b> | <b>140</b> |
| <b>FRAME</b>            |    | <b>L</b>    | <b>XL</b>  | <b>XL</b>  | <b>XL</b>  | <b>XL</b>  |
| <b>HEATING CAPACITY</b> |    | <b>13,5</b> | <b>18</b>  | <b>18</b>  | <b>18</b>  | <b>18</b>  |
| Absorbed current (OA)   | A  | 19,5        | 26         | 26         | 26         | 26         |
| First working step      | kW | 4,5         | 6,3        | 6,3        | 6,3        | 6,3        |
| Second working step     | kW | 9,0         | 11,7       | 11,7       | 11,7       | 11,7       |
| Third working step      | kW | 4,5 + 9,0   | 6,0 + 12,0 | 6,0 + 12,0 | 6,0 + 12,0 | 6,0 + 12,0 |

1. U = Under, downflow / O = Over, upflow
2. Value to be added to the weight of the standard unit.

## OPTIONAL ACCESSORIES: B803 – 3-WAY BALL VALVE (Version DX DF)

3-way motorised valve with 0÷10 VDC control and emergency manual override, for creating the third by-pass route in the hydraulic circuit.

The accessory is factory installed inside the unit and does not change its overall dimensions.

This type of valve offers the following set of benefits:

- Equipercantage characteristic
- Absence of initial flow peaks
- Excellent control stability due to the control disc
- Excellent partialisation characteristic
- Control stability
- Maintenance-free
- Self-cleaning

### 3-WAY BALL VALVE FEATURES

- Sealing with leakage rate class A (EN 12266-1)
- Maximum fluid pressure  $P_s=1600\text{kPa}$
- Maximum closing pressure (Close-off)  $\Delta P_s=1400\text{kPa}$

The rotary actuator is controlled by a 0 ... 10 VDC signal from the microprocessor control.

The actuator is equipped with an emergency manual override button and is maintenance-free.

| Model              |                     | 29       | 40       | 51       | 52       | 67       | 76       | 78        | 90        | 108       | 140       |
|--------------------|---------------------|----------|----------|----------|----------|----------|----------|-----------|-----------|-----------|-----------|
| <b>FRAME</b>       |                     | <b>M</b> | <b>M</b> | <b>M</b> | <b>L</b> | <b>L</b> | <b>L</b> | <b>XL</b> | <b>XL</b> | <b>XL</b> | <b>XL</b> |
| <b>3 WAY VALVE</b> |                     |          |          |          |          |          |          |           |           |           |           |
| <b>kv</b>          | [m <sup>3</sup> /h] | 16       | 16       | 16       | 16       | 16       | 16       | -         | -         | -         | -         |

(\*) accessory not available for XL frame

1. U = Under, Downflow / O = Over, Upflow

## IMPORTANT

For further information, please refer to chapter "CALCULATION OF THE LOAD LOSS OF A VALVE AS A FUNCTION OF WATER FLOW".

## OPTIONAL ACCESSORIES: B807 - 2-WAY VALVE EPIV (Version DX DF)



Accessory to the cooling coil and replaces the 2-way valve. Pressure-independent EPIV regulating ball valve with electronic flow control. The accessory is factory installed inside the unit and does not change its overall dimensions.

This valve type offers the following set of benefits:

- Equipercantage characteristic and control disc.
- Excellent control stability regardless of pressure variations and under all load conditions.
- Maintenance-free.
- Self-cleaning.

### EPIV VALVE FEATURES

- Sealed with leakage rate class A (EN 12266-1).
- Maximum fluid pressure  $P_s=1600\text{kPa}$ .
- Maximum closing pressure (Close-off)  $\Delta P_s=1400\text{kPa}$ .
- Maximum differential pressure  $\Delta P_{\text{max}}=350\text{kPa}$ .

**The rotary actuator is controlled by a 0 ... 10 VDC signal and is optimised for this valve type. The valve opens by turning anti-clockwise and closes by turning clockwise. The actuator is equipped with a button for manual emergency operation and is maintenance-free..**

| Model       | 29     | 40   | 51   | 52   | 67   | 76   | 78   | 90 | 108 | 140 |
|-------------|--------|------|------|------|------|------|------|----|-----|-----|
| FRAME       | M      | M    | M    | L    | L    | L    | XL   | XL | XL  | XL  |
| 3 WAY VALVE |        |      |      |      |      |      |      |    |     |     |
| kv          | [m3/h] | 14,2 | 14,2 | 14,2 | 21,3 | 21,3 | 21,3 | 32 | 32  | 32  |

## OPTIONAL ACCESSORIES: P051 – DEUMIDIFICATION FUNCTION

The accessory "P161 T/RH air intake probe" must be present.

Components:

- T / rH air intake probe.
- Electronic dew-point temperature control system for combined intervention of cooling power output and air flow rate

## OPTIONAL ACCESSORIES: 4303 - HUMIDIFIER VAP. 8 kg/h UM08

## OPTIONAL ACCESSORIES: 4305 - HUMIDIFIER VAP. 15 kg/h UM15

Accessory not available for 460/3/60 and 460/3+N/60 power supply.

Immersed electrode modulating steam humidifier equipped with electronic control with modulating steam delivery, complete with safety and operating ACCESSORIES.

A metal cover over the kettle ensures high levels of safety during operation.

Flammability safety standard UL94: V0.

The accessory includes the combined air intake temperature/humidity probe and control board.

The accessory is factory fitted and only requires a hydraulic connection for water filling.

Water is discharged from the humidifier directly into the unit's condensate drain pan and is then conveyed to the outside via the condensate drain pipe.

It is recommended to install a FILTER and a shut-off valve on the water inlet pipe.

### CHARACTERISTICS OF THE SUPPLY WATER

The quality of the used water influences the evaporation process, so the humidifier can be fed with **not-treated water, only when potable and non-demineralised**

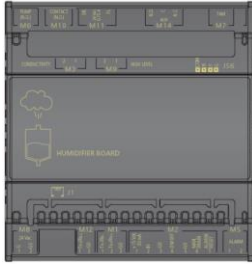

Humidifier control board

## LIMIT VALUES

|                                       |                                     | Min     | Max |
|---------------------------------------|-------------------------------------|---------|-----|
| Hydrogen ions                         | pH                                  | 7       | 8,5 |
| Specific conductivity at 20°C         | $\sigma_{R, 20^\circ C}$ $\mu S/cm$ | 350     | 750 |
| Total dissolved solids                | TDS mg/l                            | (1)     | (1) |
| Dry residue at 180°C                  | $R_{180}$ mg/l                      | (1)     | (1) |
| Total hardness                        | TH mg/l CaCO <sub>3</sub>           | 100 (2) | 400 |
| Temporary hardness                    | mg/l CaCO <sub>3</sub>              | 60 (3)  | 300 |
| Iron + Manganese                      | mg/l Fe + Mn                        | 0       | 0,2 |
| Chlorides                             | ppm Cl                              | 0       | 30  |
| Silica                                | mg/l SiO <sub>2</sub>               | 0       | 20  |
| Residual chlorine                     | mg/l Cl <sup>-</sup>                | 0       | 0,2 |
| Calcium sulphate                      | mg/l CaSO <sub>4</sub>              | 0       | 100 |
| Metallic impurities                   | mg/l                                | 0       | 0   |
| Solvents, diluents, soaps, lubricants | mg/l                                | 0       | 0   |

(1) Values depending on specific conductivity; in general:  $TDS \cong 0,93 * \sigma_{R, 20^\circ C}$ ;  $R_{180} \cong 0,65 * \sigma_R$

(2) Not lower than 200% of the chloride content in mg/l di Cl<sup>-</sup>

(3) Not lower than 300% of the chloride content in mg/l di Cl<sup>-</sup>

## WARNING:

- Use only with drinking water.
- There is no reliable relationship between hardness and water conductivity
- Do not treat water with softeners! This could cause corrosion of the electrodes or the formation of foam, leading to potential operating problems or failures.
- Do not add disinfectants or corrosion inhibitors to water, as these substances are potentially irritant.
- Is absolutely forbidden to use well water, industrial water or water drawn from cooling circuits; in general, avoid using potentially contaminated water, either from a chemical or bacteriological point of view.

## TECHNICAL DATA

|                                  |      |      | U/O  | U/O | U/O | U/O | U/O    | U/O    | U/O    | U/O    | U/O    | U/O    | U/O    |
|----------------------------------|------|------|------|-----|-----|-----|--------|--------|--------|--------|--------|--------|--------|
|                                  |      |      | 29   | 40  | 51  | 52  | 67     | 76     | 78     | 90     | 108    | 140    |        |
|                                  |      |      | M    | M   | M   | L   | L      | L      | XL     | XL     | XL     | XL     |        |
| <b>VAPOUR PRODUCTION</b>         | kg/h | 8    | 15   | 8   | 8   | 8   | 8 / 15 | 8 / 15 | 8 / 15 | 8 / 15 | 8 / 15 | 8 / 15 | 8 / 15 |
| Power input                      | kW   | 6    | 11,3 | 8   | 8   | 8   | 8 / 15 | 8 / 15 | 8 / 15 | 8 / 15 | 8 / 15 | 8 / 15 | 8 / 15 |
| Absorbed current (OA)            | A    | 8,7  | 16,2 | 8   | 8   | 8   | 8 / 15 | 8 / 15 | 8 / 15 | 8 / 15 | 8 / 15 | 8 / 15 | 8 / 15 |
| Max absorbed current (OA)        | A    | 12,4 | 23   | 8   | 8   | 8   | 8 / 15 | 8 / 15 | 8 / 15 | 8 / 15 | 8 / 15 | 8 / 15 | 8 / 15 |
| Water content                    | l    | 6,4  | 10,3 | 8   | 8   | 8   | 8 / 15 | 8 / 15 | 8 / 15 | 8 / 15 | 8 / 15 | 8 / 15 | 8 / 15 |
| Max water supply pressure        | Bar  | 1÷8  | 1÷8  | 8   | 8   | 8   | 8 / 15 | 8 / 15 | 8 / 15 | 8 / 15 | 8 / 15 | 8 / 15 | 8 / 15 |
| <b>NET WEIGHT (2)</b>            | kg   | 10   | 16   | 8   | 8   | 8   | 8 / 15 | 8 / 15 | 8 / 15 | 8 / 15 | 8 / 15 | 8 / 15 | 8 / 15 |
| <b>HYDRAULIC CONNECTION</b>      |      |      |      | 8   | 8   | 8   | 8 / 15 | 8 / 15 | 8 / 15 | 8 / 15 | 8 / 15 | 8 / 15 | 8 / 15 |
| WATER INLET - ISO 228/1 – G M    | Ø    | 3/4" | 3/4" | 8   | 8   | 8   | 8 / 15 | 8 / 15 | 8 / 15 | 8 / 15 | 8 / 15 | 8 / 15 | 8 / 15 |
| WATER OUTLET – external diameter | Ø mm | 19   | 19   | 8   | 8   | 8   | 8 / 15 | 8 / 15 | 8 / 15 | 8 / 15 | 8 / 15 | 8 / 15 | 8 / 15 |

1. U = Under, downflow / O = Over, upflow

2. Value to be added to the weight of the standard unit. Does not include the weight of the water content.

## OPTIONAL ACCESSORIES: P161 – RETURN AIR PROBE T/RH

The accessory replaces the temperature probe installed on the air intake in the indoor unit.

The probe is supplied with the following options:

- Humidifier installation.
- Dehumidification system.



**OPTIONAL ACCESSORIES P071 – REMOTE PROBE T/RH (1 probe)**  
**OPTIONAL ACCESSORIES P072 - REMOTE PROBE T/RH (2 probe)**  
**OPTIONAL ACCESSORIES P073 - REMOTE PROBE T/RH (3 probe)**  
**OPTIONAL ACCESSORIES P074 - REMOTE PROBE T/RH (4 probe)**



In addition to the on-board temperature probes, the unit's control can manage up to 4 remote T/RH probes (optional), to measure the return and the delivery air temperature in different positions.

Depending on the individual characteristics of the room and the cooling equipment, the customer can choose where to install the additional probes to achieve best measurement results (N. add. return probes + N. add. delivery probes ≤ 4).

The probes can be configured from the Service menu of the controller.

The probes that are enabled, contribute to the calculation of the return and delivery temperature used for capacity adjustment purposes.

The customer can choose between different types of calculation:

- Temperature of the first probe enabled
- Average temperature of the probes
- Highest temperature of the probes
- Lowest temperature of the probes.

**Notes:**

If a probe is connected but not enabled, its measurement can still be read on the display and by the BMS, but it is not used to calculate the adjustment temperature. It is possible to disable the probe on the unit and use only the remote probes for capacity adjustment purpose.

- **P071: One** Combined Temperature / Humidity sensor for remote installation. The optional is added to the on-board temperature sensors.
- **P072: Two** Combined Temperature / Humidity sensors for remote installation. The optional is added to the on-board temperature sensors.
- **P073: Three** Combined Temperature / Humidity sensors for remote installation. The optional is added to the on-board temperature sensors.
- **P074: Four** Combined Temperature / Humidity sensors for remote installation. The optional is added to the on-board temperature sensors

**OPTIONAL ACCESSORIES: P080 – WITHOUT AIR FILTER**

**OPTIONAL ACCESSORIES: P084 – AIR FILTER ePM10 50%**

**WITHOUT AIR FILTER**

The unit is supplied without air filters, improving the unit's energy efficiency. This configuration is only allowed when the unit is installed in a condition where the incoming air is already filtered (filtration system in the room, in the ducting, combination with plenum with filters on the unit's return)

**AIR FILTER ePM10 50%**

Air filters with ePM10 50 per cent efficiency (according to ISO EN 16890), replacing standard filters, guarantee a higher degree of filtration combined with a long service life and minimal energy consumption



**OPTIONAL ACCESSORIES: P101 - EARTHQUAKE ANCHOR KIT**

The accessory available for the indoor unit and supplied as an assembly kit consists of two lateral supports to be fixed to the sides of the unit and to the support surface.  
 This is a safety device that must be fitted by the customer before installing the unit and fixed to a structural part with adequate strength at the installation site to avoid the risk of displacement and/or overturning due to earthquakes.  
 Screws for fixing the unit to the structure are not supplied and fixing the unit to the structure is the responsibility of the Customer.  
 To guarantee earthquake resistance, the unit must be secured to a structural part with adequate strength with 4 M10 steel screws (not supplied).  
 The presence of the "ANTISISMIC ANCHORAGE KIT" accessory requires the installation of the "UNIT FIXING BRACKET".  
 The accessory excludes the installation of the plenum and unit support frame.

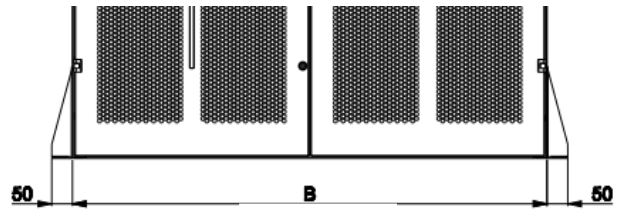
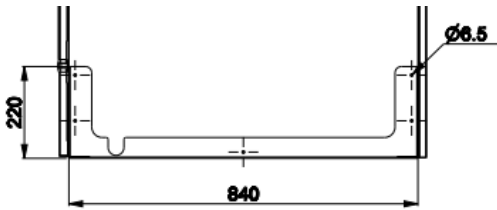

| FRAME       |    | M    | L    | XL   |
|-------------|----|------|------|------|
| Dimension B | mm | 1142 | 1600 | 2550 |

## OPTIONAL ACCESSORY: PLENUM

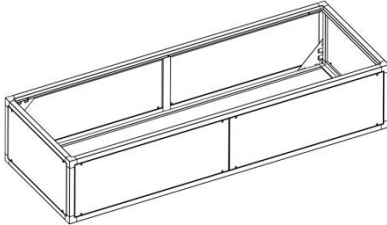

The x-MEXT series is supplied with a wide range of plenums to meet the most varied customer requirements.

The optimised structure guarantees easy installation of the plenum in the different configurations: using the connection devices supplied with the plenum, it is possible to connect the accessory to the machine from the inside (without compromising its aesthetics), quickly and easily.

The design guarantees front access for all devices requiring periodic maintenance. Removal of the filters from the front of the unit is always guaranteed.

Internal sheet steel panelling with protective surface treatment according to UNI ISO 9227/ASTMB117 and ISO 7253.

Aesthetic panels with wrinkled finish, front panels colour RAL 9006, side and rear panels colour RAL 7016, completely removable by removing the fixing screws.

Panelling insulated internally with polyurethane foam mattress.

The accessory is supplied separately and installation on the unit is the responsibility of the customer. The x-MEXT series is supplied with a wide range of plenums to meet the most varied customer requirements.

| PLENUM |      | M    | L    | XL   |
|--------|------|------|------|------|
| Height | [mm] | 510  | 510  | 510  |
| Width  | [mm] | 1142 | 1600 | 2550 |
| Depth  | [mm] | 882  | 882  | 882  |

## OPTIONAL ACCESSORY: B961/B971 - EMPTY PLENUM

## OPTIONAL ACCESSORY: B962/B972 - EMPTY PLENUM + INSULATION

The plenum is empty and can be used to raise the air intake/outlet point.

- The front panels can be removed for inspection or to remove the filters from the unit.
- Available in INSULATION version.

|                           |        | M        | L        | XL        |
|---------------------------|--------|----------|----------|-----------|
| <b>INSTALLATION</b>       |        |          |          |           |
| UNDER                     | Supply | X        | X        | X         |
|                           | Return | X        | X        | X         |
| OVER                      | Supply | X        | X        | X         |
|                           | Return |          |          |           |
| <b>WEIGHT</b>             |        | <b>M</b> | <b>L</b> | <b>XL</b> |
| EMPTY PLENUM              | [kg]   | 53,3     | 60       | 84        |
| EMPTY PLENUM + INSULATION | [kg]   | 60,2     | 70,8     | 98,4      |

## OPTIONAL ACCESSORY: B965/B975 - PLENUM 1 GRILLE

## OPTIONAL ACCESSORY: B969/B979 - PLENUM 3 GRILLES

## OPTIONAL ACCESSORY: B966/B976 - PLENUM 1 GRILLE + INSULATION

## OPTIONAL ACCESSORY: B96A/B97A - PLENUM 3 GRILLES + INSULATION

The plenum must be installed on both the supply and return lines of the machine and allows the flow of air to be directed.

- Available in the version with one GRILLE on the front panel
- Available in the version with one GRILLE on the front panel and one GRILLE for each side panel
- Front panels can be removed for inspection or to remove the filters from the unit
- Available in the version with INSULATION

# ACCESSORIES

x-MEXT DW / DW DF / DW FC

Data Book  
DB\_ME\_x-MEXT-i-G02-DX\_102022\_EN\_rev02

|                                   |        | M        | L        | XL        |
|-----------------------------------|--------|----------|----------|-----------|
| <b>INSTALLATION</b>               |        |          |          |           |
| <b>UNDER</b>                      | Supply | X        | X        | X         |
|                                   | Return | X        | X        | X         |
| <b>OVER</b>                       | Supply | X        | X        | X         |
|                                   | Return |          |          |           |
| <b>WEIGHT</b>                     |        | <b>M</b> | <b>L</b> | <b>XL</b> |
| PLENUM + 1/3 GRILLES              | [kg]   | 60,1     | 72       | 100       |
| PLENUM + 1/3 GRILLES + INSULATION | [kg]   | 64,6     | 77,4     | 107,2     |

## OPTIONAL ACCESSORY: B963/B973 - EMPTY PLENUM + DAMPER

## OPTIONAL ACCESSORY: B964/B974 - EMPTY PLENUM + DAMPER + INSULATION

The plenum must be installed above the unit and allows the unit to be excluded from air circulation when it is in OFF mode.

- Front panels can be removed for inspection or to remove the filters from the unit
- Available in the version with INSULATION

|                              |        | M        | L        | XL        |
|------------------------------|--------|----------|----------|-----------|
| <b>INSTALLATION</b>          |        |          |          |           |
| <b>UNDER</b>                 | Supply |          |          |           |
|                              | Return | X        | X        | X         |
| <b>OVER</b>                  | Supply | X        | X        | X         |
|                              | Return |          |          |           |
| <b>WEIGHT</b>                |        | <b>M</b> | <b>L</b> | <b>XL</b> |
| PLENUM + DAMPER              | [kg]   | 61,6     | 72       | 104       |
| PLENUM + DAMPER + INSULATION | [kg]   | 68,8     | 82,8     | 118,4     |

## OPTIONAL ACCESSORY: B967/B977 - PLENUM 1 GRILLE + DAMPER

## OPTIONAL ACCESSORY: B96B/B97B - PLENUM 3 GRILLES + DAMPER

## OPTIONAL ACCESSORY: B968/B978 - PLENUM 1 GRILLE + DAMPER + INSULATION

## OPTIONAL ACCESSORY: B96C/B97C - PLENUM 3 GRILLES + DAMPER + INSULATION

The plenum must be installed on the delivery side of the unit and allows the flow of outgoing air to be directed; when the unit is in OFF, it is possible to exclude it from air circulation by closing the damper.

- Front panels can be removed for inspection or to remove the filters from the unit
- Available in the version with INSULATION

|  |        | M        | L        | XL        |
|--|--------|----------|----------|-----------|
| <b>INSTALLATION</b>                        |        |          |          |           |
| <b>UNDER</b>                               | Supply |          |          |           |
|  | Return |          |          |           |
| <b>OVER</b>                                | Supply | X        | X        | X         |
|  | Return |          |          |           |
| <b>WEIGHT</b>                              |        | <b>M</b> | <b>L</b> | <b>XL</b> |
| PLENUM + 1/3 GRILLES + DAMPER              | [kg]   | 69,6     | 84       | 120       |
| PLENUM + 1/3 GRILLES + DAMPER + INSULATION | [kg]   | 73,2     | 89,4     | 127,2     |

## OPTIONAL ACCESSORY: B96F - PLENUM SILENCED

## OPTIONAL ACCESSORY: B96H - PLENUM SILENCED 1 GRILLE

The plenum must be installed on the discharge side of the machine and provides a noise reduction.

- Front panels can be removed for inspection or to remove filters from the unit
- Available in a version with a GRILLE on the front panel

|                              |        | M        | L        | XL        |
|------------------------------|--------|----------|----------|-----------|
| <b>INSTALLATION</b>          |        |          |          |           |
| UNDER                        | Supply | X        | X        | X         |
|                              | Return |          |          |           |
| OVER                         | Supply | X        | X        | X         |
|                              | Return |          |          |           |
| <b>WEIGHT</b>                |        | <b>M</b> | <b>L</b> | <b>XL</b> |
| PLENUM SILENCED              | [kg]   | 59       | 68       | 94        |
| PLENUM + SILENCED + 1 GRILLE | [kg]   | 67       | 80       | 110       |

## OPTIONAL ACCESSORY: B96G - PLENUM SILENCED + DAMPER

## OPTIONAL ACCESSORY: B96I - PLENUM SILENCED + 1 GRILLE + DAMPER

The plenum must be installed on the delivery side of the machine and allows a reduction in noise, when the unit is in OFF mode it is possible to exclude it from air circulation by closing the damper.

- Front panels can be removed for inspection or to remove filters from the unit
- Available in a version with a GRILLE on the front panel

|                                     |        | M        | L        | XL        |
|-------------------------------------|--------|----------|----------|-----------|
| <b>INSTALLATION</b>                 |        |          |          |           |
| UNDER                               | Supply |          |          |           |
|                                     | Return |          |          |           |
| OVER                                | Supply | X        | X        | X         |
|                                     | Return |          |          |           |
| <b>WEIGHT</b>                       |        | <b>M</b> | <b>L</b> | <b>XL</b> |
| SILENCED PLENUM + DAMPER            | [kg]   | 67,6     | 80       | 114       |
| SILENCED PLENUM + 1 GRILLE + DAMPER | [kg]   | 75,6     | 92       | 130       |

## OPTIONAL ACCESSORY: B96D - PLENUM + FILTER ePM 1 50%

The plenum with rigid pocket filters must be installed on the machine's supply air and provides additional filtering of the air leaving the unit, depending on the type of FILTER installed.

- Available with FILTER for particulate matter 1 µm, 50% efficiency
- Front panels can be removed for inspection or to remove the filters from the unit

|                           |        | M        | L        | XL        |
|---------------------------|--------|----------|----------|-----------|
| <b>INSTALLATION</b>       |        |          |          |           |
| UNDER                     | Supply | X        | X        | X         |
|                           | Return |          |          |           |
| OVER                      | Supply | X        | X        | X         |
|                           | Return |          |          |           |
| <b>WEIGHT</b>             |        | <b>M</b> | <b>L</b> | <b>XL</b> |
| PLENUM + FILTER ePM 1 50% | [kg]   | 59       | 68       | 94        |

## OPTIONAL ACCESSORY: B96E - PLENUM + FILTER ePM 1 50% + DAMPER

The plenum with rigid bag filters in combination with the Damper must be installed on the unit's delivery side; it guarantees additional filtering of the air leaving the unit, depending on the type of FILTER installed, and the possibility of excluding the unit from air circulation when it is in OFF mode.

- Available with FILTER for particulate matter 1 µm, 50% efficiency
- Front panels can be removed for inspection or to remove the filters from the unit

|   |        | M        | L        | XL        |
|---|--------|----------|----------|-----------|
| <b>INSTALLATION</b>                     |        |          |          |           |
| UNDER                                   | Supply |          |          |           |
|   | Return |          |          |           |
| OVER                                    | Supply | X        | X        | X         |
|   | Return |          |          |           |
| <b>WEIGHT</b>                           |        | <b>M</b> | <b>L</b> | <b>XL</b> |
| PLENUM + FILTER ePM 1 50% + DAMPER [kg] |        | 67,6     | 80       | 114       |

## OPTIONAL ACCESSORY: B97D - PLENUM + FILTER COARSE 60% A TASCA

## OPTIONAL ACCESSORY: B97E - PLENUM + FILTER COARSE 60% A TASCA + DAMPER

The plenum with soft pocket filters must be installed on the return side of the unit and provides better aerodynamic efficiency than standard filters.

- It is possible to remove the front panels for inspection or to remove the filters from the unit.
- Available in version with Damper.

|  |        | M        | L        | XL        |
|--|--------|----------|----------|-----------|
| <b>INSTALLATION</b>                      |        |          |          |           |
| UNDER                                    | Supply |          |          |           |
|  | Return | X        | X        | X         |
| OVER                                     | Supply |          |          |           |
|  | Return |          |          |           |
| <b>WEIGHT</b>                            |        | <b>M</b> | <b>L</b> | <b>XL</b> |
| PLENUM + FILTER COARSE 60% [kg]          |        | 59       | 68       | 94        |
| PLENUM + FILTER COARSE 60% + DAMPER [kg] |        | 67,6     | 80       | 114       |

## OPTIONAL ACCESSORY: B97F - PLENUM + FILTER COARSE 60%

## OPTIONAL ACCESSORY: B97G - PLENUM + FILTER COARSE 60% + 1 GRILLE

The plenum with filters is designed in combination with the OVER units with intake from the basement, to filter the aerodynamic flow in entrance to the evaporating coil.

The accessory must be installed on the unit's intake and access to the filters must be guaranteed for routine maintenance operations

- It is possible to remove the front panels for inspection or to remove the filters from the unit

|  |        | M        | L        | XL        |
|--|--------|----------|----------|-----------|
| <b>INSTALLATION</b>                        |        |          |          |           |
| UNDER                                      | Supply |          |          |           |
|  | Return |          |          |           |
| OVER                                       | Supply |          |          |           |
|  | Return | X        | X        | X         |
| <b>WEIGHT</b>                              |        | <b>M</b> | <b>L</b> | <b>XL</b> |
| PLENUM + FILTER COARSE 60% [kg]            |        | 59       | 68       | 94        |
| PLENUM + FILTER COARSE 60% + 1 GRILLE [kg] |        | 59       | 68       | 94        |

## OPTIONAL ACCESSORY: B97H - PLENUM FREE COOLING

The plenum must be installed on the air intake of the machine and allows, under certain thermo-hygrometric conditions, the room to be conditioned to be cooled directly with the air coming from outside, disposing of the thermal load without the contribution of the cooling circuit.

The damper has a double septum and the microprocessor system continuously regulates the quantity of external air to be introduced into the room to be conditioned according to the set-point. It is possible to remove the front panels for inspection or to remove the filters from the unit.

|                     |        | M        | L        | XL        |
|---------------------|--------|----------|----------|-----------|
| <b>INSTALLATION</b> |        |          |          |           |
| <b>UNDER</b>        | Supply |          |          |           |
|                     | Return | X        | X        | X         |
| <b>OVER</b>         | Supply |          |          |           |
|                     | Return |          |          |           |
| <b>WEIGHT</b>       |        | <b>M</b> | <b>L</b> | <b>XL</b> |
| PLENUM + DAMPER FC  | [kg]   | 61,6     | 72       | 104       |

### DAMPER AIR EXHAUST - Not provided

#### WARNING

**IT IS COMPULSORY TO INSTALL IN THE ROOM TO BE CONDITIONED A MOTORIZED DAMPER APPROPRIATELY DIMENSIONED FOR THE EXHAUSTION OF AIR FROM THE ROOM DURING FREE-COOLING OPERATION.**

During free-cooling operation, the air conditioner supplies ambient air directly into the room, this causes an increase in air pressure inside the room.

The exhaust damper avoids the increase in pressure in the room.

The damper must be installed at the highest point of the room to exhaust excess hot air to the outside. Install the damper if possible, in opposite position to air conditioner.

The damper is controlled by the modulating signal 0-10Vdc of the free-cooling control of the air conditioner. The 24Vac power supply of the servomotor and the 0-10Vdc free-cooling signal is available on the unit's electrical terminal block (see wiring diagram for connections). Air exhaust must be protected with a rain cover and a grille (at Customer care). The electrical connection cables are not supplied.

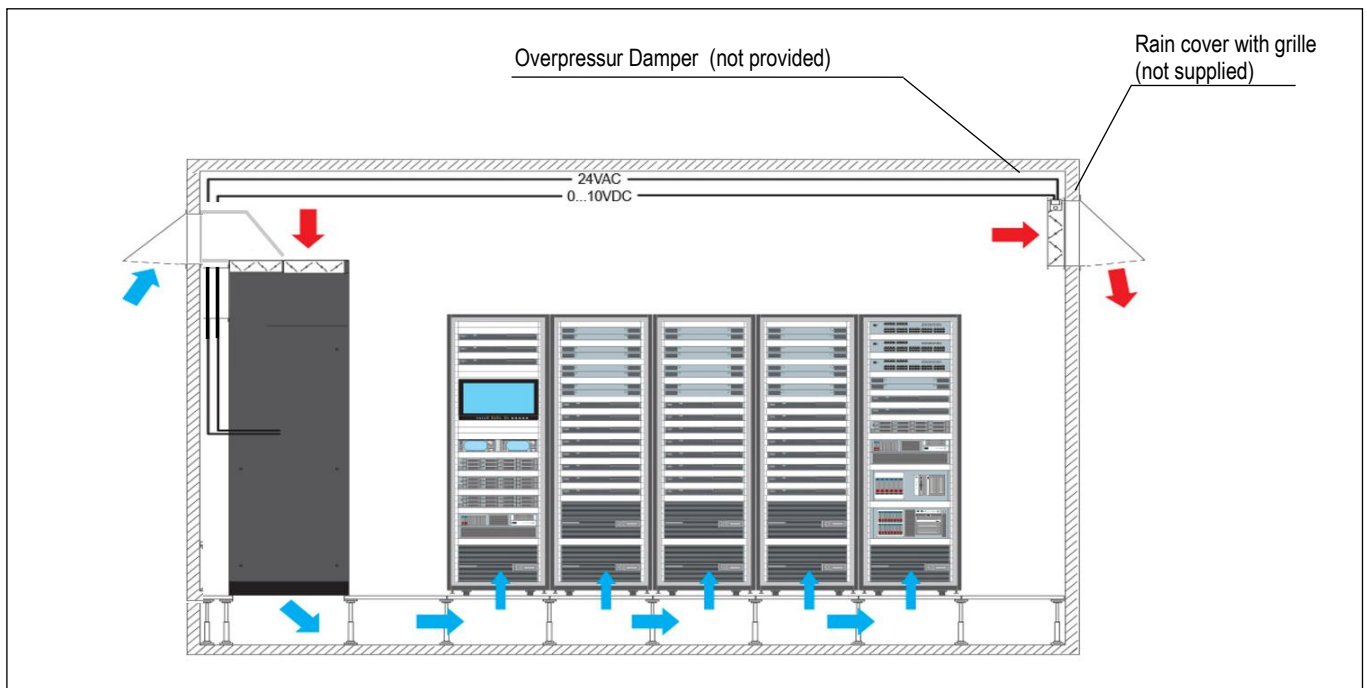

## OPTIONAL ACCESSORIES: A531 - DAMPER ON-OFF

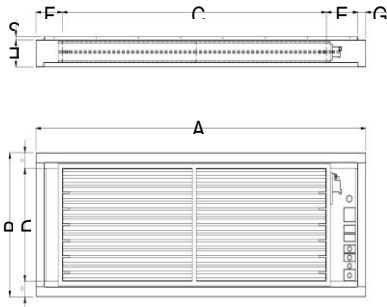

Motorised ON/OFF non-return air damper positioned above the unit in both UNDER and OVER versions.

The Damper opens when the fans start up to allow the correct flow of air into the unit during operation. When the unit has an alarm or when it is set to OFF, the Damper closes excluding the unit from air circulation.

In the UNDER version the Damper is equipped with levers that allow it to be lifted without the use of tools, to guarantee easy and safe removal of the air filters from the front during normal maintenance operations.

The accessory can be supplied together with the plenum and support frame, for details please refer to the dedicated chapter.

The accessory mandatorily requires the presence of accessory "9973 Packaging with wooden cage".

### STRUCTURE

- Sheet steel frame with protective surface treatment according to UNI ISO 9227/ASTMB117 and ISO 7253, and painted with epoxy powders. Colour RAL 9005;

- Damper with opposed fins made of sheet steel;
- Servo motor for damper control;
- Terminal box for electrical connection to the unit.

| DAMPER ON/OFF   |      | M   | L    | XL   |
|-----------------|------|-----|------|------|
| N° DAMPERS      | [-]  | 1   | 1    | 2    |
| Height *        | [mm] | 80  | 80   | 80   |
| Lenght Damper * | [mm] | 969 | 1423 | 1133 |
| Depth Damper *  | [mm] | 750 | 750  | 750  |
| WEIGHT Damper * | [kg] | 8,6 | 12   | 10   |

\* data referred to single Damper

## OPTIONAL ACCESSORIES: B981 - SUPPORTING FRAME H 350 – 500 mm

## OPTIONAL ACCESSORIES: B982 - SUPPORTING FRAME H 500 - 750 mm

## OPTIONAL ACCESSORIES: B983 - SUPPORTING FRAME H 750 - 1000 mm

The accessory is supplied as an assembly kit and includes the unit's support frame and its attachment to the machine base (internal fixing).

The new design allows for easy installation and quick height adjustment. The footprint is completely integrated into the machine's floor plan. It is not possible to install the support frame together with the plenums underneath the machine.

The frame is available in 3 different heights for installation flexibility.

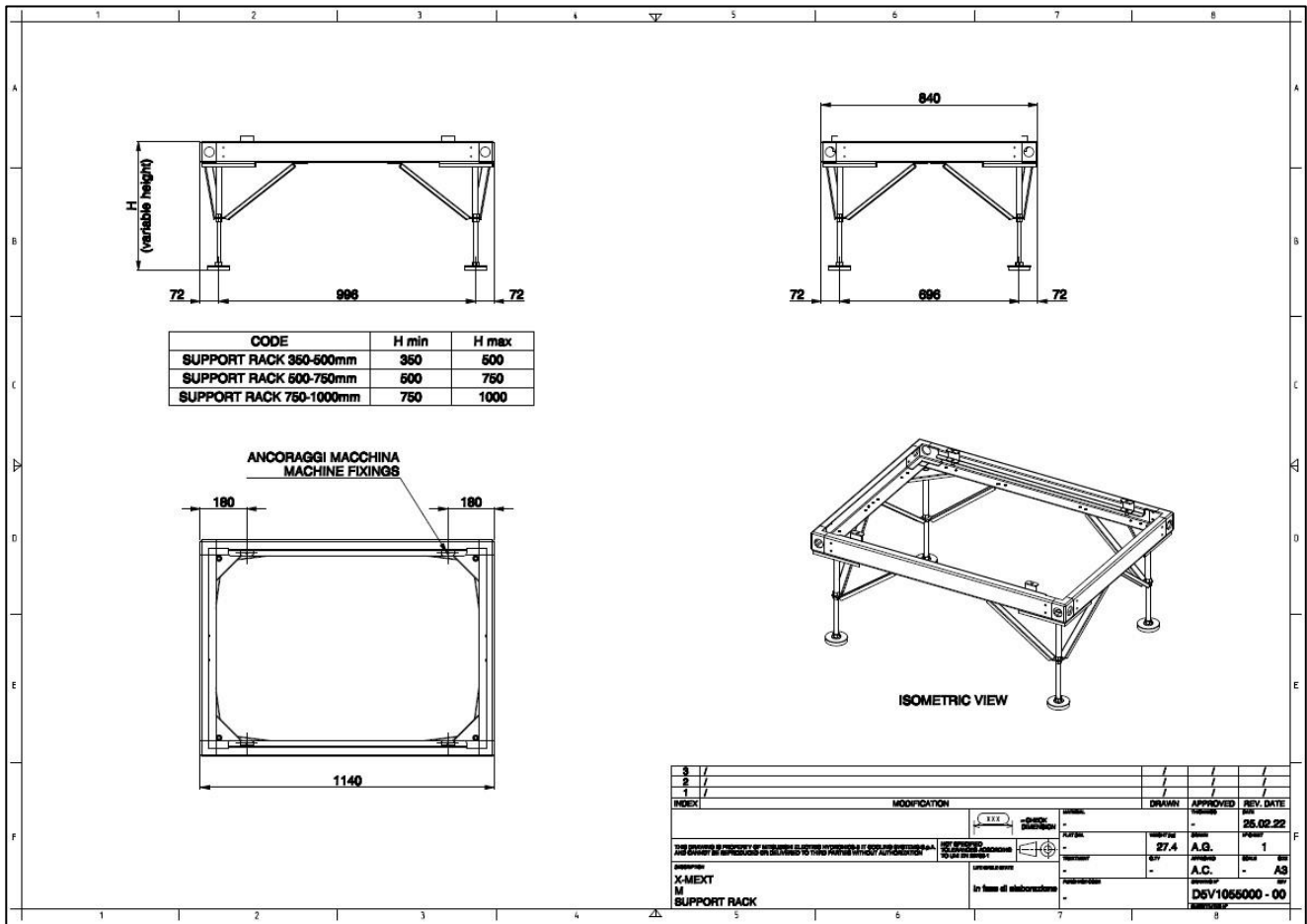

| B981 - H max 500  |      | M    | L    | XL   |
|-------------------|------|------|------|------|
| Min Height        | mm   | 350  | 350  | 350  |
| Max Height        | mm   | 500  | 500  | 500  |
| WEIGHT            | [kg] | 27,4 | 39,5 | 48,5 |
| B982 - H max 750  |      | M    | L    | XL   |
| Min Height        | mm   | 500  | 500  | 500  |
| Max Height        | mm   | 750  | 750  | 750  |
| WEIGHT            | [kg] | 27,7 | 39,8 | 48,8 |
| B983 - H max 1000 |      | M    | L    | XL   |
| Min Height        | mm   | 750  | 750  | 750  |
| Max Height        | mm   | 1000 | 1000 | 1000 |
| WEIGHT            | [kg] | 28   | 40,1 | 49,1 |



## ACCESSORY: B991 – INSULATION

The accessory is designed to acoustically insulate the air-conditioning unit's panels. The sound pressure reduction of the unit is approximately 2dB(A). The reduction refers only to the radiated sound level values or the front of the unit (blind front panels).

The noise data on the intake and supply ports are not reduced.

The rear, side and front panels (not GRILLEti) consist of:

- External part with painted sheet metal panel
- Sound-absorbing insulation
- Inner part in hot-dip galvanised sheet steel

The insulation provides fire protection comparable to Class 0 according to EN 13501-1.

The accessory, when combined with the OVER units, obligatorily requires that the air return is carried out from the basement of the unit and the presence of the blind front panel.

The accessory increases the weight of the unit.

|            |    | WEIGHT |    |     |
|------------|----|--------|----|-----|
| FRAME      |    | M      | L  | XL  |
| UNDER/OVER | kg | 36     | 44 | 144 |

# DRILLING OF RAISED FLOOR FOR UNDER MACHINES

x-MEXT DX / DF

Data Book  
DB\_ME\_x-MEXT-i-G02-DX\_102022\_EN\_rev02

## DRILLING OF RAISED FLOOR WITHOUT SUPPORT FRAME

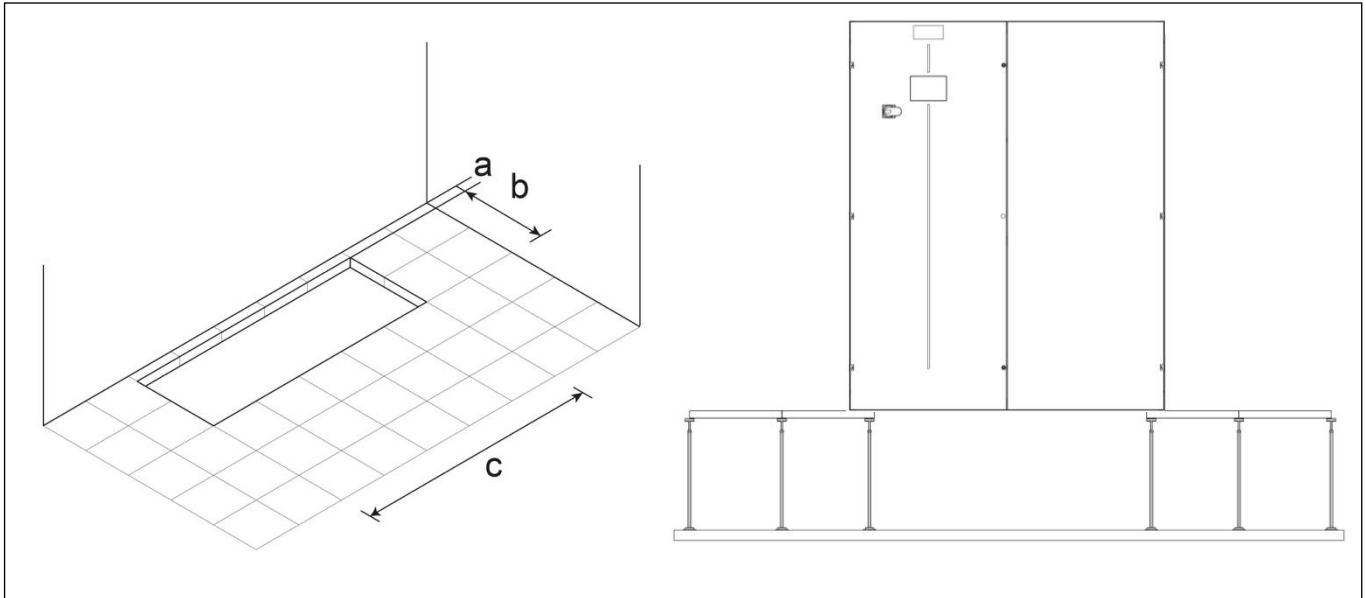

Provide a hole of the size shown in the table

| FRAME |    | M    | L    | XL   |
|-------|----|------|------|------|
| a     | mm | 60   | 60   | 60   |
| b     | mm | 765  | 765  | 765  |
| c     | mm | 1082 | 1540 | 2490 |

## DRILLING OF RAISED FLOOR WITH SUPPORT FRAME

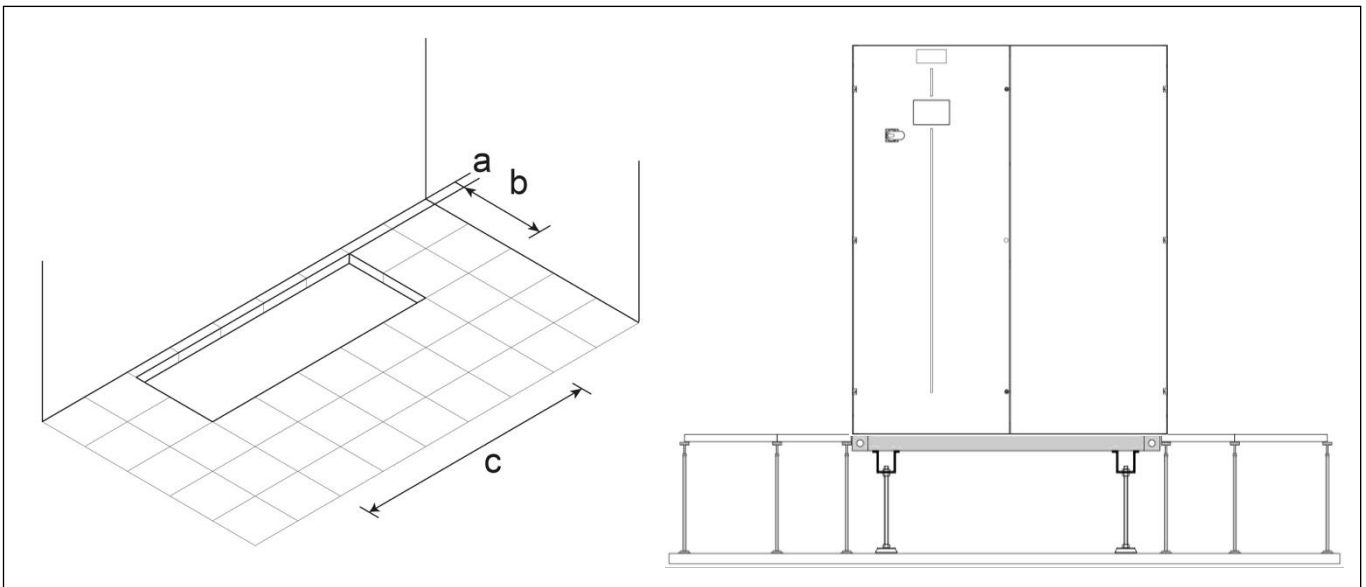

Provide a hole of the size shown in the table

| FRAME |    | M    | L    | XL   |
|-------|----|------|------|------|
| a     | mm | 25   | 25   | 25   |
| b     | mm | 840  | 840  | 840  |
| c     | mm | 1142 | 1600 | 2250 |

**M UNDER**  
Dimensions in mm

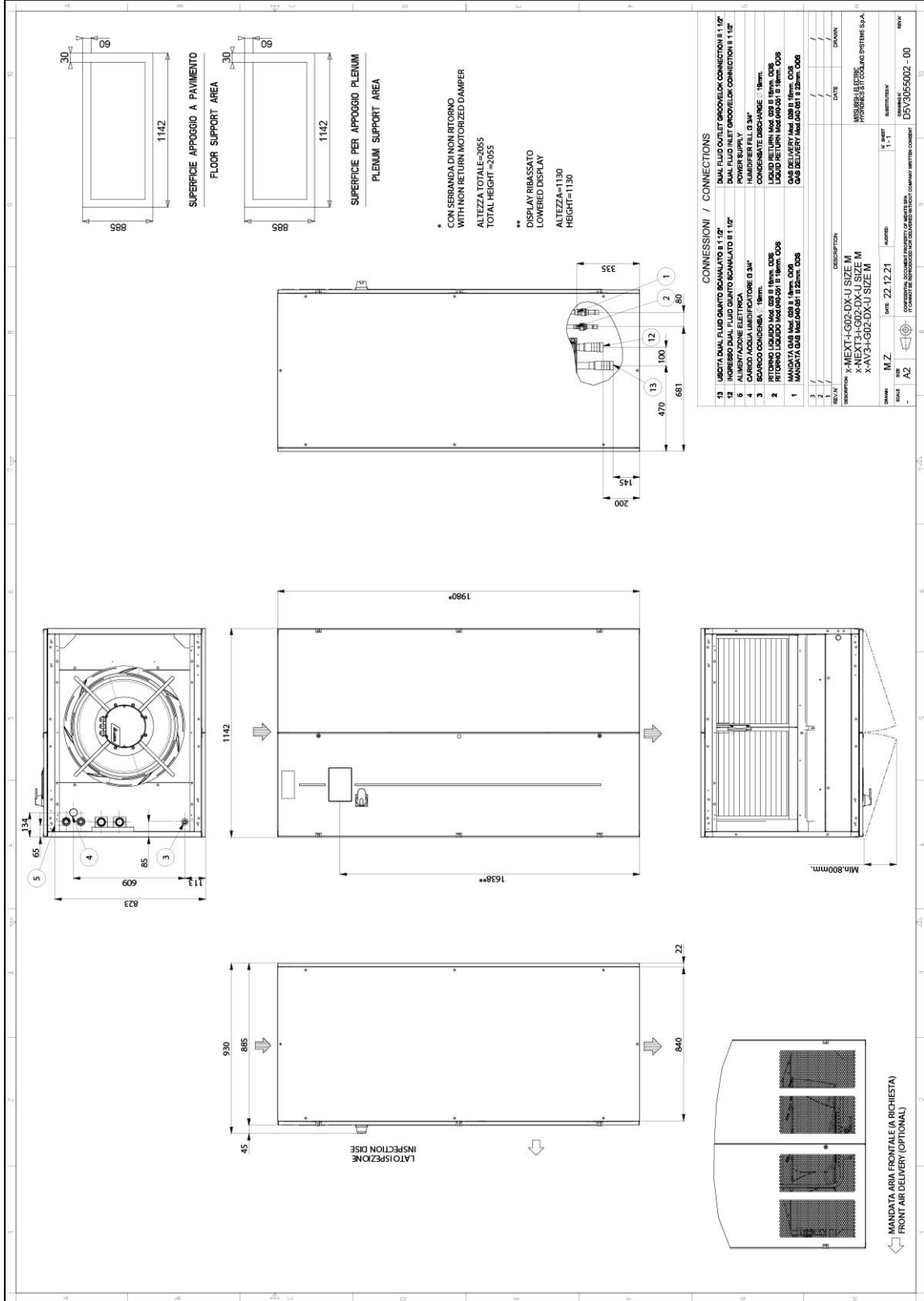













EXAMPLE FOR MACHINES NOISE EMISSION CALCULATION

UNDER MACHINE WITH DUCT ON AIR INTAKE

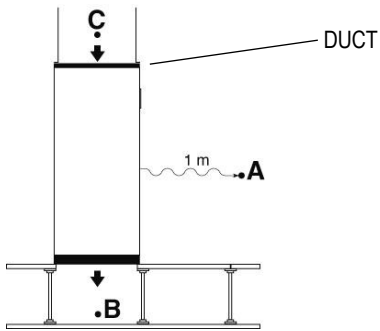

- Lp A = Front side Under catalogue value
- Lp B = Air delivery Under catalogue value
- Lp C = Air intake Under catalogue value
- The points B and C do not influence the point A

UNDER MACHINE WITH PLENUM ON AIR DELIVERY

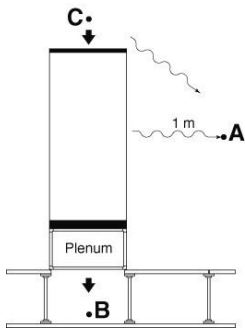

- Lp A = Front side Under catalogue value
- Lp B = Air delivery Under catalogue value –plenum noise reduction
- Lp C = Air intake Under catalogue value
- $$Lp A+C = 10 \log_{10} \left( 10^{\frac{LpA}{10}} + 10^{\frac{LpC}{10}} \right)$$
- The points B and C do not influence the point A

UNDER MACHINE WITH PLENUM ON AIR INTAKE

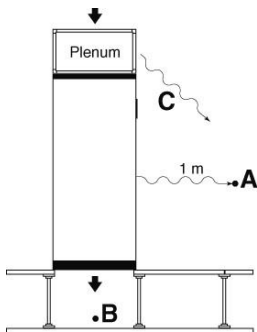

- Lp A = Front side Under catalogue value
- Lp B = Air delivery Under catalogue value –plenum noise reduction
- Lp C = Air intake Under catalogue value
- $$Lp A+C = 10 \log_{10} \left( 10^{\frac{LpA}{10}} + 10^{\frac{LpC}{10}} \right)$$
- The points B and C do not influence the point A

OVER MACHINE WITH DUCT

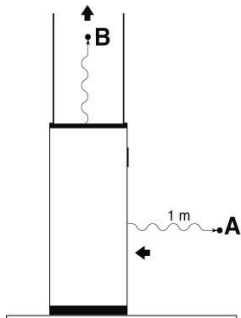

- Lp A = Air intake Over catalogue value
- Lp B = Air delivery Over catalogue value
- The points B and C do not influence the point A

## OVER MACHINE WITH PLENUM ON AIR DELIVERY

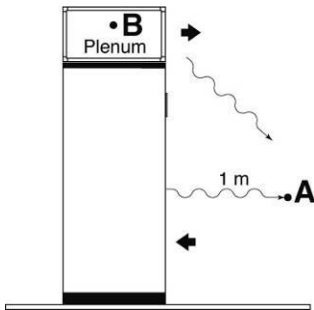

Lp A = Air intake Over catalogue value

Lp B = Air delivery Over catalogue value – plenum noise reduction

$$Lp A+B = 10 \log_{10} \left( 10^{\frac{LpA}{10}} + 10^{\frac{LpC}{10}} \right)$$

## OVER MACHINE WITH DUCT AND PLENUM ON AIR DELIVERY

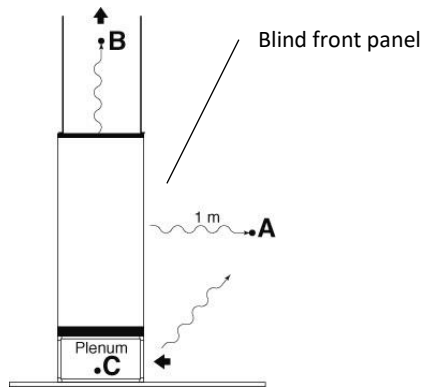

Lp A = Front side Over catalogue value

Lp B = Air delivery Over catalogue value

Lp C = Lp A + 6dB(A) - plenum noise reduction

$$Lp A+C = 10 \log_{10} \left( 10^{\frac{LpA}{10}} + 10^{\frac{LpC}{10}} \right)$$

The point B do not influence the point A+C

## OVER MACHINE WITH DUCT AND PLENUM ON AIR DELIVERY

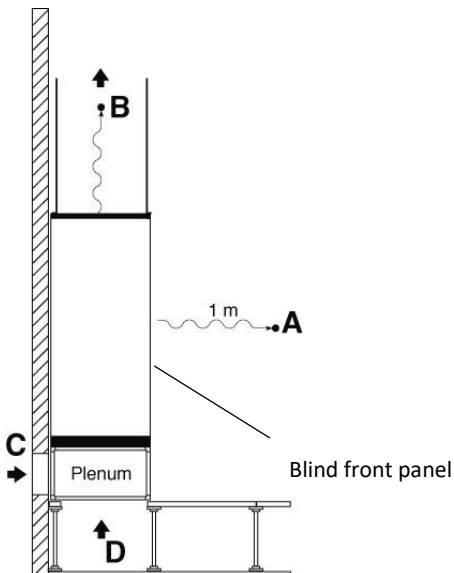

Lp A = Front side Over catalogue value

Lp B = Air delivery Over catalogue value

Lp C = Lp D = Lp A + 6 dB(A) - plenum noise reduction

The points B, C and D do not influence the point A

### IMPORTANT

The declared noise levels are intended in free field conditions.

The noise pressure level of an installed unit is affected by the room acoustic characteristics.

Please consider an average noise increase of +4/+6 dB(A).

# VALVE PRESSURE DROP CALCULATION AS FUNCTION OF WATER FLOW RATE

x-MEXT DX / DF

Data Book

DB\_ME\_x-MEXT-i-G02-DX\_102022\_EN\_rev02

Flow coefficient kv defines the water flow (between 5°C and 40°C) expressed in m<sup>3</sup>/h that cross a valve with a pressure drop of 1bar (100kPa).

With this data is possible to calculate the localized pressure drop as function of the water flow rate.

$$dP = (Q / kv)^2$$

dP (bar) = localized pressure drop of valve;

Q (m<sup>3</sup>/h) = water flow rate – it varies according to the desired operating condition;

kv (m<sup>3</sup>/h) = valve flow coefficient.

The formula allows to calculate the value of the localized pressure drop (in bar).

The pressure drops values showed on the documentation are supplied in kPa.

Is possible to change from one unit to another through the following conversion.

1 bar = 100kPa

# AIR FILTERS REPLACEMENT FOR UNDER VERSION MACHINES SIZE M - L - XL

x-MEXT DX / DX DF

Data Book  
DB\_ME\_x-MEXT-i-G02-DX\_102022\_EN\_rev02

Thanks to the new design of the unit, it is possible to extract the air filters for routine maintenance operations from the front of the machine, both in installations with free unit intake and when there is a plenum, ducting or damper. The air filters are foldable and allow easy extraction. When a return plenum is present, the front panel of the plenum must be removed using the screws provided to access the air filters. When a damper is present, there is a lifting system that locks the damper in the open position, guaranteeing access to the filtering section. When ducting is present, access to the filtering section must be provided by means of a removable door.

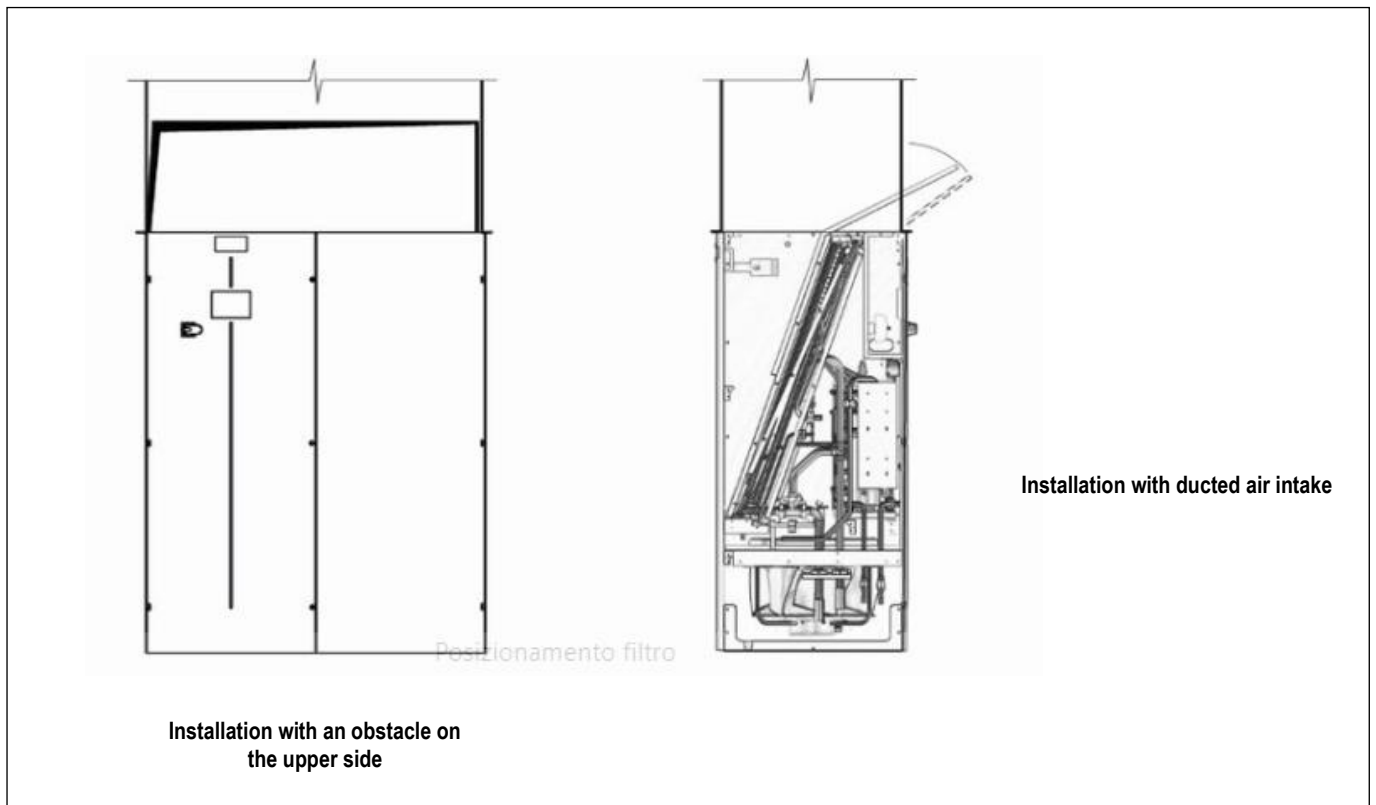
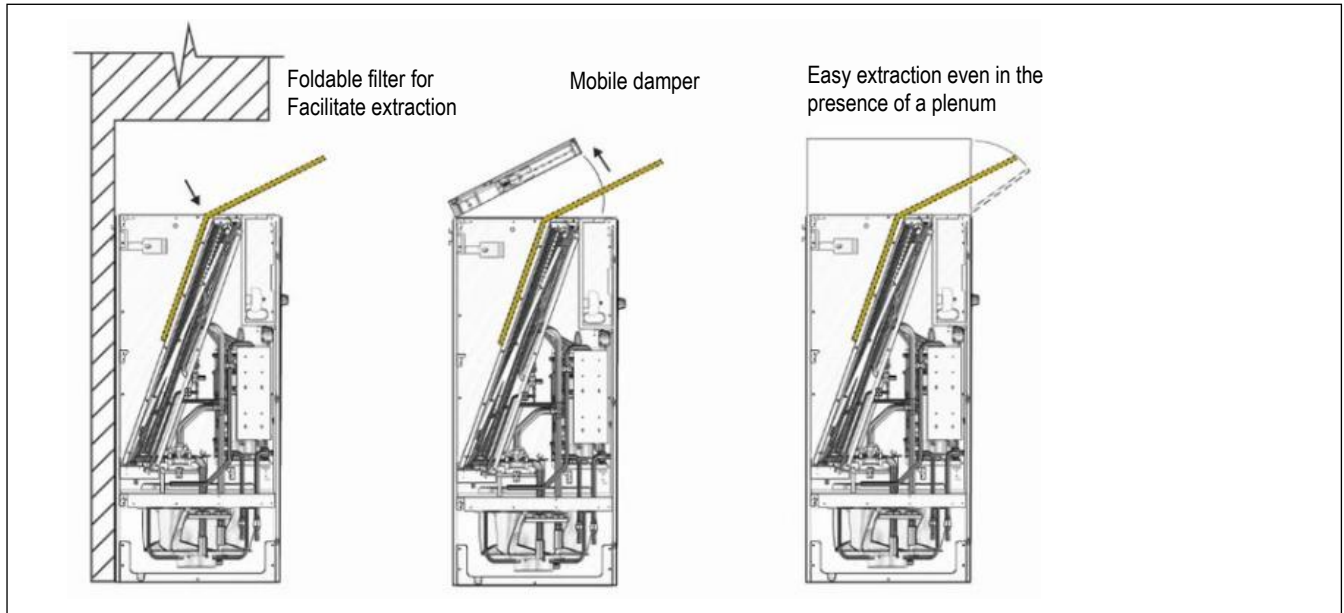

## SHIPMENT: PACKAGING DIMENSIONS

Values referred to basic machine. The presence of some ACCESSORIES increases the weight of machine.  
The machines are shipped on pallet and covered with shrink wrap.  
On request packing on pallet covered with shrink wrap and wooden cage.

**STANDARD PACKING DIMENSIONS:**  
Pallet + Nylon

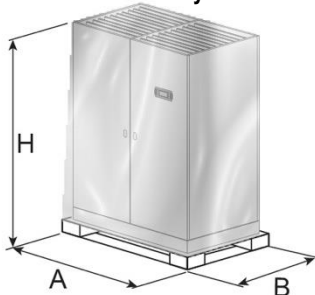

| FRAME | A (mm) | B (mm) | H (mm) |
|-------|--------|--------|--------|
| M     | 1410   | 1115   | 2185   |
| L     | 1870   | 1115   | 2185   |
| XL    | 2830   | 1115   | 2185   |

**OPTIONAL 9969: Pallet + Wooden cage + Nylon**

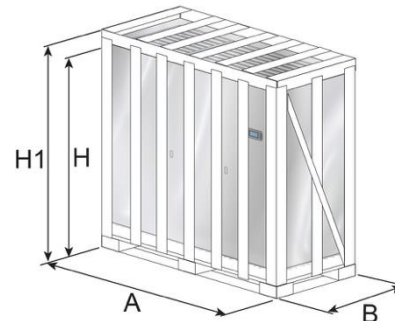

| FRAME | A (mm) | B (mm) | H (mm) | H1 (*) (mm) |
|-------|--------|--------|--------|-------------|
| M     | 1410   | 1115   | 2275   | 2425        |
| L     | 1870   | 1115   | 2275   | 2425        |
| XL    | 2830   | 1115   | 2275   | 2425        |

H1 (\*) = Packaging height with Damper installed on unit

## SHIPMENT WEIGHT

### STANDARD PACKING - DX

| Model        | 29 | 40  | 51  | 52  | 67  | 76  | 78  | 90  | 108 | 140  |      |
|--------------|----|-----|-----|-----|-----|-----|-----|-----|-----|------|------|
| Frame        | M  | M   | M   | L   | L   | L   | XL  | XL  | XL  | XL   |      |
| WEIGHT UNDER | kg | 397 | 405 | 408 | 510 | 553 | 554 | 889 | 896 | 1005 | 1007 |
| WEIGHT OVER  | kg | 388 | 397 | 400 | 492 | 535 | 536 | 849 | 856 | 965  | 967  |

### ACCESSORYO 9969: WOODEN CAGE PACKING - DX

| Model            | 29 | 40  | 51  | 52  | 67  | 76  | 78  | 90  | 108 | 140  |      |
|------------------|----|-----|-----|-----|-----|-----|-----|-----|-----|------|------|
| Frame            | M  | M   | M   | L   | L   | L   | XL  | XL  | XL  | XL   |      |
| WEIGHT UNDER     | kg | 442 | 450 | 453 | 562 | 605 | 606 | 961 | 968 | 1077 | 1079 |
| WEIGHT UNDER (1) | kg | 447 | 455 | 458 | 568 | 611 | 612 | 969 | 976 | 1085 | 1087 |
| WEIGHT OVER      | kg | 433 | 442 | 445 | 544 | 587 | 588 | 921 | 928 | 1037 | 1039 |
| WEIGHT OVER (1)  | kg | 438 | 447 | 450 | 550 | 593 | 594 | 929 | 936 | 1045 | 1047 |

(1) Machine with accessory A531 Damper on/off - WEIGHT Damper to add up

# SHIPMENT

x-MEXT DX / DF

Data Book

DB\_ME\_x-MEXT-i-G02-DX\_102022\_EN\_rev02

## STANDARD PACKING – DF DX

| Model        |    | 29  | 40  | 51  | 52  | 67  | 76  | 78  | 90  | 108  |
|--------------|----|-----|-----|-----|-----|-----|-----|-----|-----|------|
| Frame        |    | M   | M   | M   | L   | L   | L   | XL  | XL  | XL   |
| WEIGHT UNDER | kg | 448 | 457 | 460 | 581 | 626 | 627 | 940 | 947 | 1058 |
| WEIGHT OVER  | kg | 440 | 449 | 452 | 564 | 609 | 610 | 899 | 907 | 1018 |

## OPTIONAL ACCESSORY 9969: WOODEN CAGE PACKING – DF DX

| Model            |    | 29  | 40  | 51  | 52  | 67  | 76  | 78   | 90   | 108  |
|------------------|----|-----|-----|-----|-----|-----|-----|------|------|------|
| Frame            |    | M   | M   | M   | L   | L   | L   | XL   | XL   | XL   |
| WEIGHT UNDER     | kg | 493 | 501 | 505 | 633 | 678 | 679 | 1012 | 1019 | 1130 |
| WEIGHT UNDER (1) | kg | 498 | 507 | 510 | 639 | 684 | 685 | 1020 | 1027 | 1138 |
| WEIGHT OVER      | kg | 485 | 494 | 497 | 616 | 661 | 662 | 972  | 979  | 1090 |
| WEIGHT OVER (1)  | kg | 490 | 499 | 502 | 622 | 667 | 668 | 979  | 987  | 1098 |

(1) Machine with accessory A531 Damper on/off - WEIGHT Damper to add up

## ACCESSORIES PACKING DIMENSIONS AND SHIPMENT WEIGHT

| Dimensions/weights pallet                  |      | M                         | L    | XL   |
|--|------|---------------------------|------|------|
| WEIGHT pallet (to add at WEIGHT accessory) | [kg] | 25                        | 33   | 50   |
| Lenght                                     | [mm] | 1410                      | 1870 | 2830 |
| Width                                      | [mm] | 1115                      | 1115 | 1115 |
| Plenum                                     |      |                           |      |      |
| Packing type                               | [-]  | Pallet + film heat shrink |      |      |
| Height                                     | [mm] | 660                       | 660  | 660  |
| Support frame                              |      |                           |      |      |
| Packing type                               | [-]  | Pallet + film heat shrink |      |      |
| Height                                     | [mm] | 400                       | 400  | 400  |

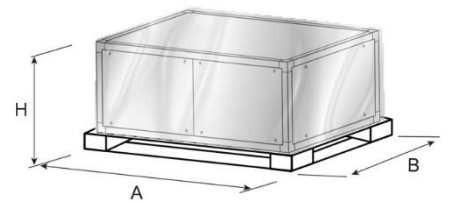

Packing plenum

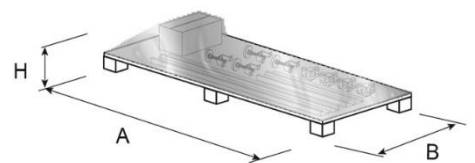

Packing support frame

| Kit dual power supply |      | M             | L         | XL      |
|-----------------------|------|---------------|-----------|---------|
| Packing type          | [-]  | Cardboard box | Cardboard | plastic |
| WEIGHT packing        | [kg] | 5             | 5         | 12      |
| Lenght                | [mm] | 500           | 500       | 600     |
| Width                 | [mm] | 400           | 400       | 450     |
| Height                | [mm] | 210           | 210       | 228,5   |

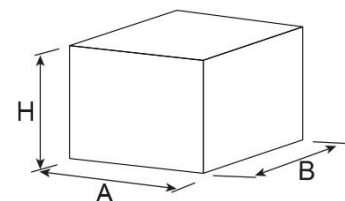

Packing kit dual power supply



## KIT DUAL POWER SUPPLY FOR SIZES M / L

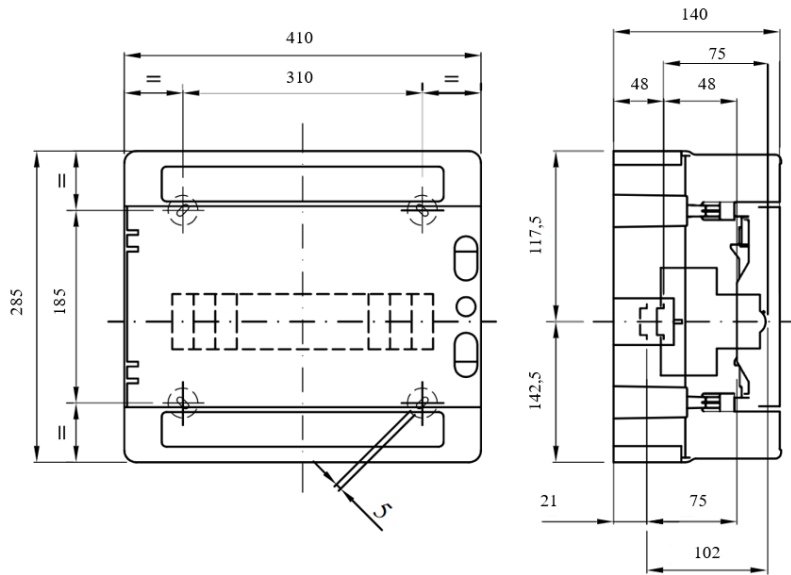

## KIT DUAL POWER SUPPLY FOR SIZE XL

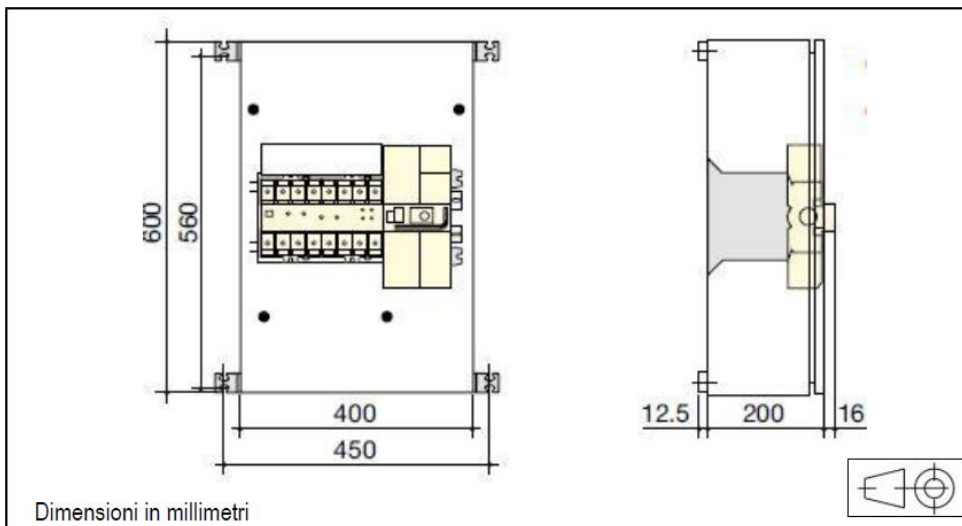

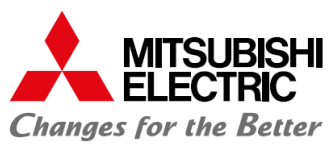

**Mitsubishi Electric Europe B.V.**  
**Italian Branch**

Campus, Energy Park  
Via Energy Park 14,  
20871 Vimercate (MB)