



MITSUBISHI ELECTRIC Package Air-Conditioner Grille (Optional Part) Automatic Filter Elevation Panel Operation Manual

[PLP-6EAJ
PLP-6EAJE (with "i-see Sensor")]

Note
This symbol mark is for EU countries only.
This symbol mark is according to the directive 2006/66/EC Article 20 Information for end-users and Annex II.
Your MITSUBISHI ELECTRIC product is designed and manufactured with high quality materials and components which can be recycled and/or reused.
This symbol means that batteries and accumulators, at their end-of-life, should be disposed of separately from your household waste.
If a chemical symbol is printed beneath the symbol shown above, this chemical symbol means that the battery or accumulator contains a heavy metal at a certain concentration. This will be indicated as follows:
Hg: mercury (0,0005%), Cd: cadmium (0,002%), Pb: lead (0,004%)
In the European Union there are separate collection systems for used batteries and accumulators.
Please, dispose of batteries and accumulators correctly at your local community waste collection/recycling centre.
Please, help us to conserve the environment we live in!

- For correct and safe use, make sure to read this manual thoroughly before using this product.
- In addition to this manual, read the operation manual for the air-conditioner.
- After reading this manual, the users must keep this readily at hand, together with the operation manual for the air-conditioner and the installation manual for the indoor unit and the grille.

Safety precautions

• Symbols used in this manual are categorized as follows according to the degree of risk when used improperly:

	Warning Describes warnings that must be observed to prevent serious consequences, such as serious injury or death of the user.		Absolutely not
	Caution Describes precautions that must be observed to prevent damage to the unit.		Must be done as instructed

Precautions when using

<p>Warning</p> <p>Do not place any objects other than the filter on the grille. Do not hang on the lowered intake grille.</p> <p>• Doing so may cause an injury due to a drop or a fall.</p> <p>Stop the unit before performing the up/down operation of the intake grille.</p> <p>• Otherwise, the intake grille may drop off and cause an injury or a failure.</p>	<p>Do not mix substances other than the designated refrigerant in the refrigerant cycle when installing and/or moving the unit.</p> <p>• If air or other substances mix in, abnormal high-pressure will occur in the refrigerant cycle, which may cause explosion. Mixing other than the specified refrigerant may heavily effect on the safety guarantee due to the mechanical failure, system malfunction, unit breakdown or accidents.</p>
<p>Caution</p> <p>Perform the up/down operation only to clean the filter and the intake grille.</p> <p>• Otherwise, it may cause an injury or a failure.</p> <p>Do not touch or swing the string (suspender) and the intake grille during an up/down operation.</p> <p>• Doing so may cause a collision of the intake grille or twining of the string, resulting in an injury or a failure of the up/down device.</p> <p>Do not apply downward force on the intake grille when cleaning the filter.</p> <p>• Doing so may cause a failure of the up/down device.</p>	<p>Do not perform up/down operations consecutively or repeatedly. Do not leave the intake grille lowered.</p> <p>• Doing so may cause an injury or a failure of the up/down device.</p> <p>Do not bend the string, or put objects such as an edge tool or lit cigarette on the string.</p> <p>• Doing so may cause the intake grille or the filter to drop off due to string breakage, resulting in an injury.</p> <p>Keep the wireless remote controller away from children.</p> <p>• Otherwise, it may cause an injury. • Prevent children from accidentally swallowing batteries.</p> <p>Before performing the up/down operation of the intake grille, confirm the safety of the surroundings.</p> <p>• Otherwise, the intake grille may hit people or objects and cause damage to them.</p>

1. Parts names

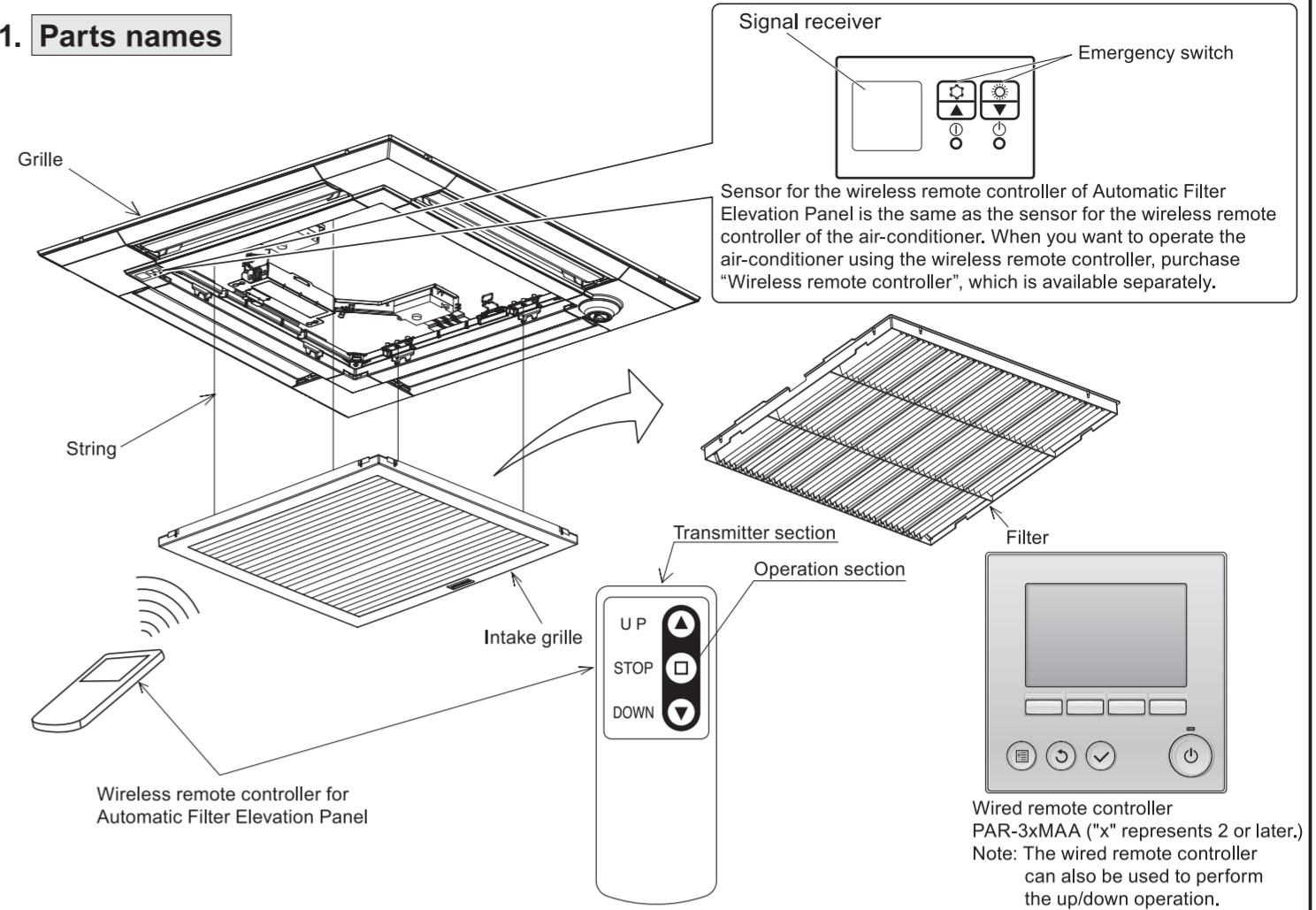

2. How to handle the wireless remote controller (Automatic Filter Elevation Panel)

- When using the wireless remote controller, point it towards the sensor from right under the grille.
- The receiver blips to inform you that the signal from the wireless remote controller has been received. Signals can be received up to approximately 3 meters in a straight line from the controller in an area approximately 30 degrees to the left and right of the controller. However, illumination such as fluorescent lights and strong light can affect the ability to receive signals.
- Do not drop the wireless remote controller or subject it to strong shocks. In addition, do not get the wireless remote controller wet or leave it in a location with high humidity.
- To avoid misplacing the wireless remote controller, keep it in the provided remote controller holder which should be secured to something such as a wall using the provided screws. Make sure to place the wireless remote controller back in place after use. Note: For the details, refer to the installation manual for Automatic Filter Elevation Panel.

How to set battery

- Press and hold the wireless remote controller with a sharp object such as a ballpoint pen in the direction of the arrow (1) and slide toward the direction of the arrow (2) to remove the battery case.
- Use the lithium battery (CR2025, 3V).
- Insert the battery into the battery case with the positive side up and install the case back onto the wireless remote controller.
- To remove the battery, reverse the installation procedure.

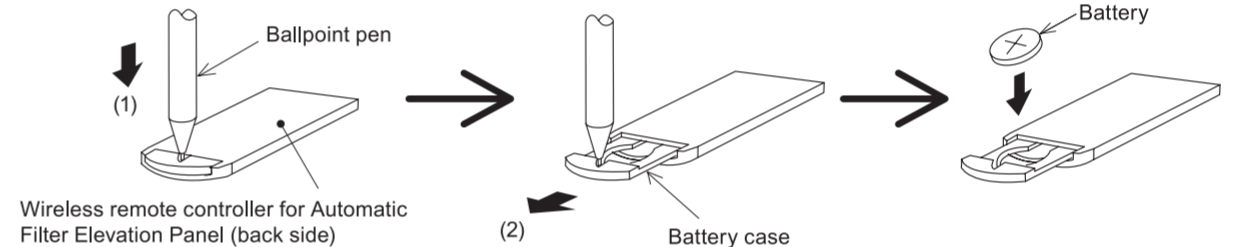

3. How to perform the up/down operation of the intake grille

Using Wireless remote controller:

- 1) Make sure to turn the air-conditioner "OFF".
- 2) Press the "Down" button of the wireless remote controller for Automatic Filter Elevation Panel to lower the intake grille.

Note1. By initial setting, the intake grille will automatically stop at a lowering distance of 1.6 m from the ceiling level. If you want to change the initial setting of lowering distance, contact your dealer. (The distance can be changed to 1.2 m, 2.0 m, 2.4 m, 2.8 m, 3.2 m, 3.6 m and 4.0 m. These must be used only as a guide. You must lower the intake grille yourself to check the exact distance.)

- 2) When you want to stop the intake grille while it is lowering, press the "STOP" or "UP" button on the remote controller to stop at that position.

- 3) Remove the filter or intake grille and clean them.

Note: Refer to the section on how to clean up.

- 4) Press the "UP" button on the remote controller to put the intake grille in place.

Note1. If the intake grille is not placed in the correct position at a time, the operation is automatically retried.

- 2) When you want to stop the intake grille while it is rising, press the "STOP" or "DOWN" button on the remote controller to stop at that position.

Using the wired remote controller [PAR-3xMAA ("x" represents 2 or later.)] :

Note1. Raise or lower the intake grilles of the air-conditioners managed by the remote controller. Install the remote controller in a place where you can observe all the air-conditioners managed with it. Otherwise, the lowering grille may hit people or objects and cause damage to them.

- 2) Depending on the connected outdoor unit, operation may not be possible.

[Wired remote controller function]

Function buttons

The functions of the function buttons change depending on the screen. Refer to the button function guide that appears at the bottom of the LCD for the functions they serve on a given screen.

<p>Main display</p> <p>Function button F1</p> <ul style="list-style-type: none"> • Main display: Press to change the operation mode. • Main menu: Press to move the cursor down. <p>Function button F2</p> <ul style="list-style-type: none"> • Main display: Press to decrease the set temperature. • Main menu: Press to move the cursor up. <p>Function button F3</p> <ul style="list-style-type: none"> • Main display: Press to increase the set temperature. • Main menu: Press to go to the previous page. <p>Function button F4</p> <ul style="list-style-type: none"> • Main display: Press to change the fan speed. • Main menu: Press to go to the next page. 	<p>MENU button</p> <ul style="list-style-type: none"> • Press to bring up the Main menu. <p>RETURN button</p> <ul style="list-style-type: none"> • Press to return to the previous screen. <p>ON/OFF button</p> <ul style="list-style-type: none"> • Press once to turn ON and twice to OFF. <p>SELECT button</p> <ul style="list-style-type: none"> • Press to save the setting.
---	---

Operation procedure

[Procedure 1] Turn the air-conditioner "OFF" and select "Auto descending panel" using the remote controller.

- 1) Select "Maintenance menu" from the main menu with the [F1] and the [F2] button, and press the [OK] button.
- 2) Select "Auto descending panel" from the maintenance menu with the [F1] and the [F2] button, and press the [OK] button.
- 3) Select "Descending operation" from the auto descending panel with the [F1] and the [F2] button, and press the [OK] button.

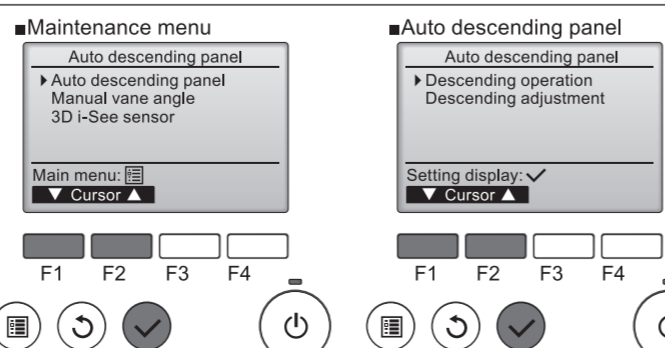

[Procedure 2] Lower the intake grille

<When used in combination with PLA-EA>

Select "Ref. address", "Unit No." and "Operation" with the [F1] button.

To lower the intake grille, specify "Ref. address" and "Unit No." of the unit. Select "Down" for "Operation" with the [F2] and the [F3] button, and press the [OK] button.

Ref. address : 0 to 15, all in a lump
Unit No. : 1,2,3,4, All

<When used in combination with PLFY-EM>

Select "M-NET address" and "Operation" with the [F1] button.

To lower the intake grille, specify "M-NET address" of the unit. Select "Down" for "Operation" with the [F2] and the [F3] button, and press the [OK] button.

[Remarks]

If the target unit is unknown, press [F4]. After a while, the airflow direction of only the displayed air-conditioner will be switched downward. (The vane of the untargeted air-conditioners will all be blocked.) Press [OK] as confirmation completed.

<When used in combination with PLA-EA> <When used in combination with PLFY-EM>

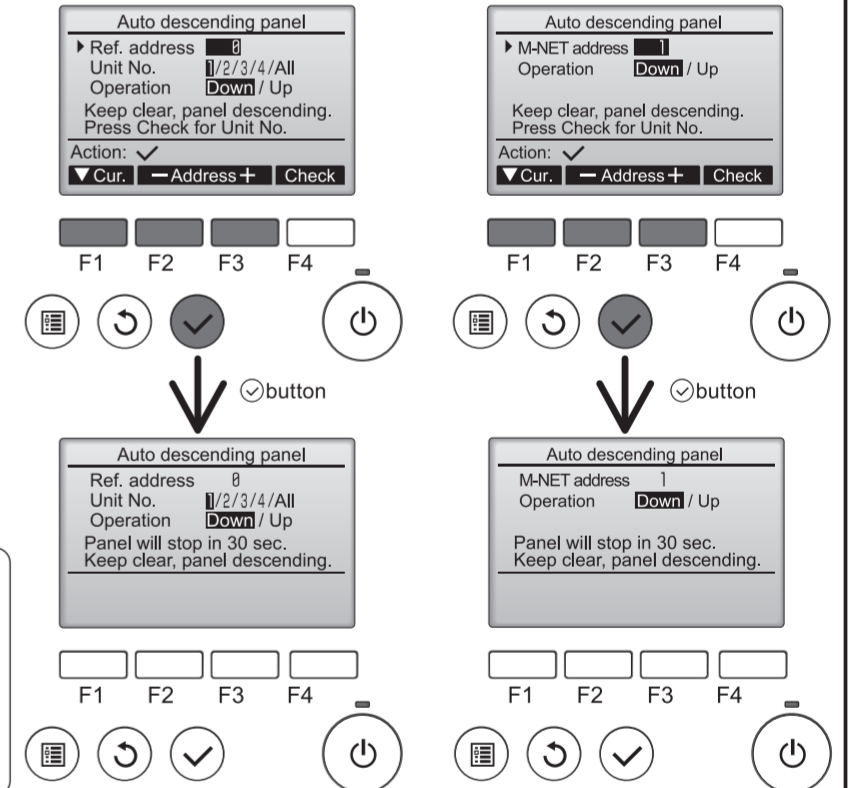

- You cannot stop the operation while the intake grille is lowering.

Note: If you press the [OK] button while lowering, the intake grille may stop lowering, but it will not stop immediately.

- By the initial setting, the intake grille will automatically stop at the lowering distance of 1.6 m from the ceiling level.

Note: If you want to change the initial setting of lowering distance, refer to the installation manual or contact your dealer. (The distance can be changed to 1.2 m, 2.0 m, 2.4 m, 2.8 m, 3.2 m, 3.6 m, and 4.0 m. These must be used only as a guide. Make sure to lower the intake grille yourself to check the exact distance.)

[Procedure 3] Remove the filter and/or intake grille to clean them.

Refer to the section on how to clean up the intake grille and clean the filter and intake grille.

[Procedure 4] Put the intake grille in the place.

<When used in combination with PLA-EA>

Refer to [Procedure 2] to set "Ref. address" and "Unit No." "Up" and press the [OK] button.

<When used in combination with PLFY-EM>

Refer to [Procedure 2] to set "M-NET address" "Up" and press the [OK] button.

- You cannot stop the operation while the intake grille is rising.

Note: If you press the [OK] button while rising, the intake grille may stop rising, but it will not stop immediately.

[Procedure 5] Exit the "Auto descending panel".

- 1) Press [OK] to return to "Maintenance menu".
- 2) Press [OK] button on "Maintenance menu". Complete the ending process and return to "Main menu".

Using the wired remote controller (PAR-21MAA series) :

Note: Raise or lower all the intake grilles managed by the remote controller at the same time.
Install the remote controller in a place where you can observe all the air-conditioners managed with it.
Otherwise, the lowering grille may hit people or objects and cause damage to them.

1) Make sure to turn the air-conditioner "OFF".

Note: The up/down operation mode is only available when the air-conditioner is "OFF".

2) Press both the "FILTER" and "Ventilation" buttons simultaneously for 2 seconds or more to enter the up/down operation mode.

"Up/down operation mode" display



Stop the unit before performing the up/down operation of the intake grille.

• Otherwise, the intake grille may drop off and cause an injury or a failure.

3) Press the TEMP. (V) button. After a while, the intake grille will begin lowering.

"Standby for lowering" display



• You cannot stop the operation while the intake grille is lowering.
Note: If you press the (A) button while lowering, the intake grille may stop lowering, but it will not stop immediately.
• By the initial setting, the intake grille will automatically stop at the lowering distance of 1.6 m from the ceiling level.
Note: If you want to change the initial setting of lowering distance, contact your dealer. (The distance can be changed to 1.2 m, 2.0 m, 2.4 m, 2.8 m, 3.2 m, 3.6 m, and 4.0 m. These must be used only as a guide. Make sure to lower the intake grille yourself to check the exact distance.)

"Lowering" display (blinking)



"Stop" display (When finished lowering)



4) Remove the filter and/or intake grille to clean them. (Refer to the section on how to clean up.)

5) Press the TEMP. (A) button. After a while, the intake grille will begin to rise and then be put back into place.

"Standby for raising" display



"Raising" display (blinking)



"Stopped" display (when the intake grille has been put back into place.)



6) Exit the up/down mode either by pressing the "ON/OFF" button or by holding down both the "FILTER" and "Ventilation" buttons simultaneously for 2 seconds or more.

Note: After exiting the up/down mode, wait for about 30 seconds to perform the next operation. The remote controller will not accept any operation for that period.

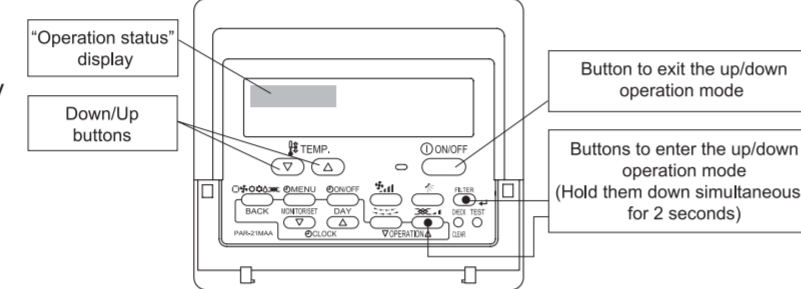

• Up/down operation with the individually-specified air-conditioner <When used in combination with PLA-EA>
Note: Raise or lower the intake grille of the specific air-conditioner that you select from all that are managed by that remote controller.

1) Make sure to turn the air-conditioner "OFF".
Note: The up/down operation mode is only available when the air-conditioner is "OFF".



Stop the unit before performing the up/down operation of the intake grille.

• Otherwise, the intake grille may drop off and cause an injury or a failure.

2) Press both the "FILTER" and "Ventilation" buttons simultaneously for 2 seconds or more to enter the up/down operation mode.



"Up/down operation mode"

3) Press the "Ventilation" button. After a while, it will switch to the "individually-specified up/down operation mode".



"Up/down operation mode" → "Individually-specified up/down operation mode"



In the upper right figure, the air-conditioner of which Ref. address No. "00" and Unit No. "1" is currently selected.

If the number of the target air-conditioner is unknown, go to 4).

If the number of the target air-conditioner is known, go to 5).

5

4) If you press the (FILTER) button when the "Unit No." or "Address No. of indoor unit" is blinking, after a while, the up/down airflow direction of only the displayed air-conditioner will be switched downward. (The vanes of untargeted air-conditioners will all be blocked.)

■ In Step 5) described below, identify the target air-conditioner by switching the "Unit No." and "Ref. address No." and by pressing the (FILTER) button to check the up/down airflow direction.

5) Select the "Unit No." and "Ref. address No."

■ To change "Unit No." or "Ref. address No.", use "TEMP." buttons (V) (A) when the panel displays (a) or (b) below.

■ Every time you press the "Mode selection" button, the target of operation will switch as illustrated below.

[Remarks]

■ If "Err" is displayed when you press the "FILTER" button to check the target air-conditioner, the air-conditioner with that "Unit" or "Ref. address" does not exist. Check and set that air-conditioner again.

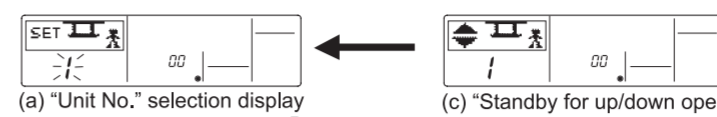

(a) "Unit No." selection display

(c) "Standby for up/down operation" display

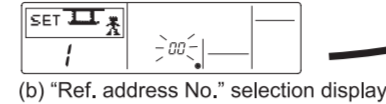

(b) "Ref. address No." selection display

6) Continue to press the "Mode selection" button until "Standby for up/down operation" is displayed.



"Standby for up/down operation" display

The following steps are the same as steps 3) to 6) described in the "General Operation" section. So refer to that section.

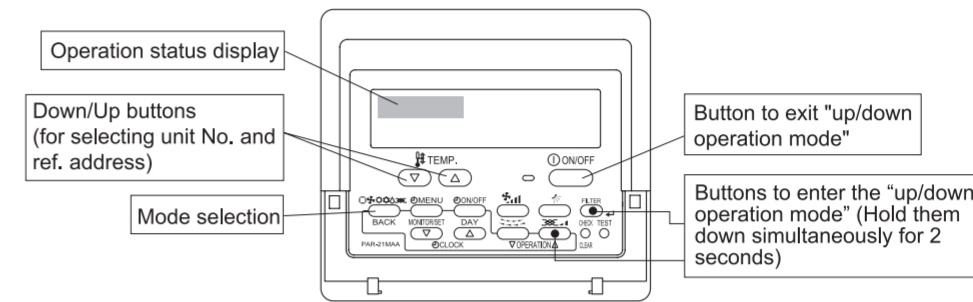

• Up/down operation with the individually-specified air-conditioner <When used in combination with PLFY-EM>
Note: Raise or lower the intake grille of the specific air-conditioner that you select from all that are managed by that remote controller.

1) Make sure to turn the air-conditioner "OFF".

Note: The up/down operation mode is only available when the air-conditioner is "OFF".

2) Press both the "FILTER" and the "Ventilation" buttons simultaneously for 2 seconds or more to enter the up/down operation mode.



"Up/down operation mode"

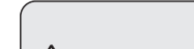

Stop the unit before performing the up/down operation of the intake grille.

• Otherwise, the intake grille may drop off and cause an injury or a failure.

3) Press the "Ventilation" button. After a while, it will switch to the "individually-specified up/down operation mode".

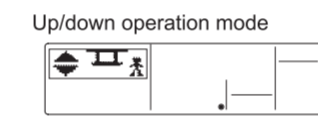

Up/down operation mode

Individually-specified up/down operation mode

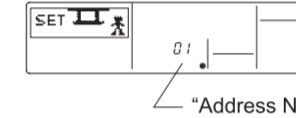

In the upper right figure, the air-conditioner of which indoor unit address No. "01" is currently selected.

If the number of the target air-conditioner is unknown, go to 4).

If the number of the target air-conditioner is known, go to 5).

6

4) If you press the (FILTER) button when the "Address No. of indoor unit" is blinking, after a while, the up/down airflow direction of the displayed air-conditioner will be switched downward. (The vanes of untargeted air-conditioners will all be blocked.)

■ In Step 5) described below, identify the target air-conditioner by changing the "Address No. of indoor unit" and by pressing the (FILTER) button to check the up/down airflow direction.

5) Select the "Address No. of indoor unit".

■ "Address No. of indoor unit" can be changed by using the "TEMP." buttons (V) (A) when the panel displays (a) or (b) below.

■ Every time you press the "Mode selection" button, the target of operation will change as illustrated below.

[Remarks]

■ If "Err" is displayed when you press the "FILTER" button to check the target air-conditioner, the air-conditioner with that "Address No. of indoor unit" does not exist. Check and set that air-conditioner again.



(a) "Address No. of indoor unit" selection display

(b) "Standby for up/down operation" display

[Remarks]

■ Each press changes the "Address No. of indoor unit" from "01 to 50"

6) Continue to press the "Mode selection" button until "Standby for up/down operation" is displayed.



"Standby for up/down operation" display

The following steps are the same as steps 3) - 6) described in the "General Operation" section. So refer to that section.

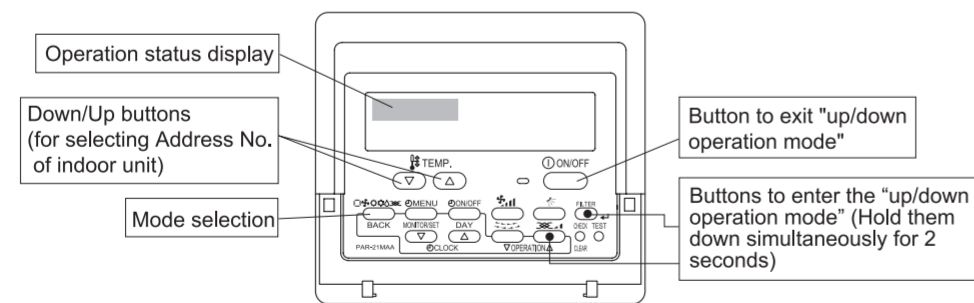

Precautions when operating

- The intake grille can be raised or lowered only if it is suspended with four strings.
- Do not attempt to pull down the intake grille manually and forcibly.
- Do not perform the up/down operations consecutively or repeatedly.
- When you lower the intake grille, make sure that no obstacles are situated under the grille.
- After the cleaning, place the filter back into the intake grille.

4. How to clean up

Cleaning the filter

- 1) Clean the filters using a vacuum cleaner. If you do not have a vacuum cleaner, tap the filters against a solid object to knock off dirt and dust.
- 2) If the filters are especially dirty, wash them in lukewarm water. Take care to rinse off any detergent thoroughly and allow the filters to dry completely before putting them back into the unit.

Caution:

1. Do not dry the filters in direct sunlight or by using a heat source, such as an electric heater: this may warp them.
2. Do not wash the filters in hot water (above 50°C), as this may warp them.
3. Make sure to install it in the correct direction. (180-degree counterclockwise is acceptable but reversing the front and back sides is not acceptable.)
4. Make sure that the air filters are always installed. Operating the unit without air filters can cause malfunction.
5. Before you start cleaning, stop operation and turn OFF the power supply.
6. Indoor units are equipped with filters to remove the dust of sucked-in air. Clean the filters using the methods shown in the right sketches.

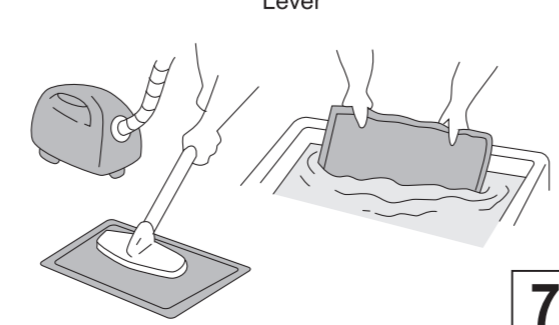
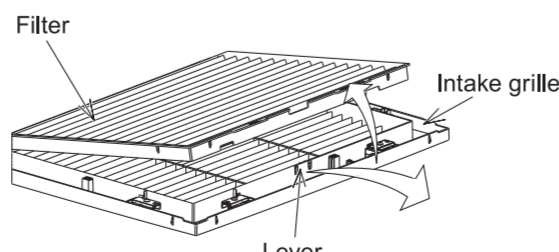

7

Cleaning the intake grille

- 1) Press and hold the claw in the circular hole of grille support with a sharp object such as a driver (in the direction of the arrow ①), and slide the joint (in the direction of the arrow ②) to remove the intake grille.

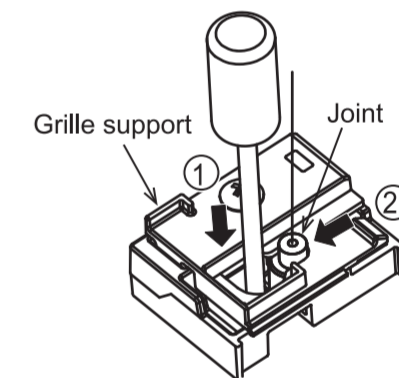

Note: Never pull the string as doing so may cause a failure.

2) Wash the intake grille with water.

- Wash it as you wipe gently using a soft cloth. When finished washing, wipe off moisture with a soft cloth and dry the intake grille in the shade.
- When using a mild household detergent (for dishes or clothing), take care to rinse off any detergent thoroughly.
- Do not use gasoline, paint thinner, polishing powder or acidic/alkaline detergent as these may damage the intake grille.
- Do not soak the intake grille in water or lukewarm water for a long time (2 hours or longer).
- Do not dry the intake grille in direct sunlight or by using a heat source. (This may warp or discolor it.)

3) Reinstall the intake grille (by reverse procedure for removal).
Note: There is no constraint on the direction.

5. Emergency up/down operation

When the wireless remote controller cannot be used (in the case of battery discharge, misplacing of the wireless remote controller, malfunctioning and so on), the emergency switch on the sensor can be used as an alternative.

- To lower the intake grille: Press the button once. (For emergency heating operation, hold down this button.)
- To raise the intake grille: Press the button once. (For emergency cooling operation, hold down this button.)

• To stop the intake grille from moving: Use the opposite buttons to those used to initiate movement. (To stop it from lowering, press the "Up" button; To stop it from rising, press the "Down" button.)

Note: When doing this, particular caution must be taken not to fall.

6. Troubleshooting

• Check the following points before contacting your dealer.

Problem	Possible Reason	Corrective Action
Intake grille does not function with operation of the remote controller.	Air-conditioner is running.	Stop running the air-conditioner and try again.
	Power failure.	After recovering from power failure, try again.
	Batteries are not inserted into the wireless remote controller. Or battery power is running low.	Install or replace the battery.
Intake grille cannot be placed in the correct position.	There is something on the intake grille.	Remove the objects or obstacles from the intake grille. Or, remove the stuck object.
	Filter is not properly installed.	Lower the intake grille again and check whether the filter is installed in the correct position.
	Intake grille is not hung with all four hooks.	Lower the intake grille again and hang the hook on the intake grille.
Intake grille stops lowering in mid flow. (Intake grille would not lower any further.)	Because the intake grille has finished lowering to the auto-stop position.	This is normal. Note: If you want to change the setting for the lowering distance, contact your dealer.
Noises are made during up/down operation. (While intake grille is moving up/down.)	This is the noise made when the string is wound and unwound.	This is normal.
Noises are made while placing the intake grille in.	This is the operational noise for placing the intake grille in securely.	
Intake grille repeats rising and lowering several times while being placed in the correct position.	This is the operation for placing the intake grille in securely.	
Intake grille leans toward one side during the up/down operation.	The speeds of winding each string is slightly different.	

Note: If you still have problems after checking the points described above, consult your dealer. Do not try to repair it yourself.

8