Procon

MELCOBEMS

FOR INSTALLERS

INSTALLATION AND OPERATION MANUAL Version 1.05

For safe and correct use, please read this installation manual thoroughly before installing the MelcoBEMS.

MITSUBISHI ELECTRIC

Preface

Safety warnings

⚠ Caution:

Do not expose to rain or moisture.

⚠ Screened Signal Cables:

Use only screened cables for connecting peripherals to any Procon MelcoBEMS device to reduce the possibility of interference with radio communications services. Using screened cables ensures that you maintain the appropriate EMC classification for the intended environment.

⚠ CE Notice:

This product has been determined to be in compliance with 2004/108/EC (EMC Directive) and amendments of the European Union.

⚠ European Union, Class A:

Class A products are intended for use in non-residential/non-domestic environments. Class A products may also be utilised in residential/domestic environments but may cause interference and require the user to take adequate corrective measures.

This is a Class A product. In a domestic environment this product may cause radio frequency interference in which case the user may be required to take adequate measures.

A "Declaration of Conformity" in accordance with the preceding directives and standards has been made and is available on request.

If this equipment does cause interference with radio communications services, which can be determined by turning the equipment off and on, you are encouraged to try to correct the interference by one or more of the following measures:

- Reorient the receiving antenna.
- Relocate the Procon MelcoBEMS with respect to the receiver.
- Move the Procon MelcoBEMS away from the receiver.

If necessary, consult a Procon MelcoBEMS technical support representative or an experienced radio/television or EMC technician for additional suggestions.

Disclaimer

⚠ Warranty:

All products manufactured on behalf of Mitsubishi Electric UK are warranted against defective materials for a period of three years from the date of delivery to the original purchaser.

⚠ Warning:

Mitsubishi Electric UK assumes no liability for damages consequent to the user of this product. We reserve the right to change this manual at any time without notice. The information furnished by us is believed to be accurate and reliable. However, no responsibility is assumed by us for its use, nor for any infringements of patents or other rights of third parties resulting from its use.

Contents

Preface	2
Safety warnings	2
1. Safety precautions	8
2. Overview	9
2.1. Overview when using an EB50.....	9
2.2. Overview when using an EB50 with Energy Monitoring.....	10
3. Size and weight	11
4. Getting Started	12
4.1. Unpacking.....	12
4.2. Before Switching On	12
5. Installation	13
5.1. Selecting an Installation Site	13
5.2. Installation.....	13
5.2.1. Physical unit installation	13
5.2.2. Power supply.....	13
5.2.3. Connection Details	14
5.3. Ethernet.....	14
5.4. Initial Power On.....	14
5.5. Status Indicators	14
6. Configuration, Fire Alarm enable link and Webpages settings	15
6.1. Air-Conditioning Group Configuration	15
6.2. Unit operation.....	15
6.3. Fire Alarm enable link	16
6.4. Reset Button	16
6.5. Time clock.....	16
6.6. Centralised Controller Group Configuration Learning	16
6.7. Webpages Settings.....	16
6.7.1. Landing page	17
6.7.2. IP address	18
6.7.3. Modbus and BACnet settings	18
6.7.4. Upgrade MelcoBEMS Firmware	20
7. Modbus	21
7.1. Serial comms port (Modbus Only)	21
7.2. Modbus Registers	21
7.2.1. OC/BC Error Codes.....	23
7.2.2. Additional Register Usage	23
7.2.3. Parameters Settings.....	24
7.2.4. Modbus Table Overview	25
7.2.5. Special Function Descriptions.....	26
7.2.6. Floating points and decimal points on temperatures	26
7.2.7. Port Configurations (Modbus Only).....	27
7.2.8. Modbus Global Parameters	27
8. BACnet	28
8.1. Specification	28
8.2. Object Types.....	28
8.3. Object List.....	29
8.4. Object Name.....	31
8.5. System Objects.....	32
9. Energy Monitoring with Modbus and BACnet	34
9.1. Overview.....	34
9.2. Important note about Energy monitoring.....	34
9.3. Collecting information.....	35
9.3.1. Daily monitoring.....	35
9.3.2. Monthly monitoring	35
10. Applicable Models	36
11. Important Notes	37
12. Declaration of Conformity	38

1

**[Fig. 1]
Included Items**

A



B



C



D



- A 1 x MELCOBEMS
- B 1 x Green RS232/485 Serial cable
- C 1 x Red Fire Alarm Enable Link Cable
- D 2 x Din rail mounted kit
4 x Self tapping screws

Note: The Ethernet cables and the hub/switch must be supplied by others

2

[Fig. 2]
Outside of Unit

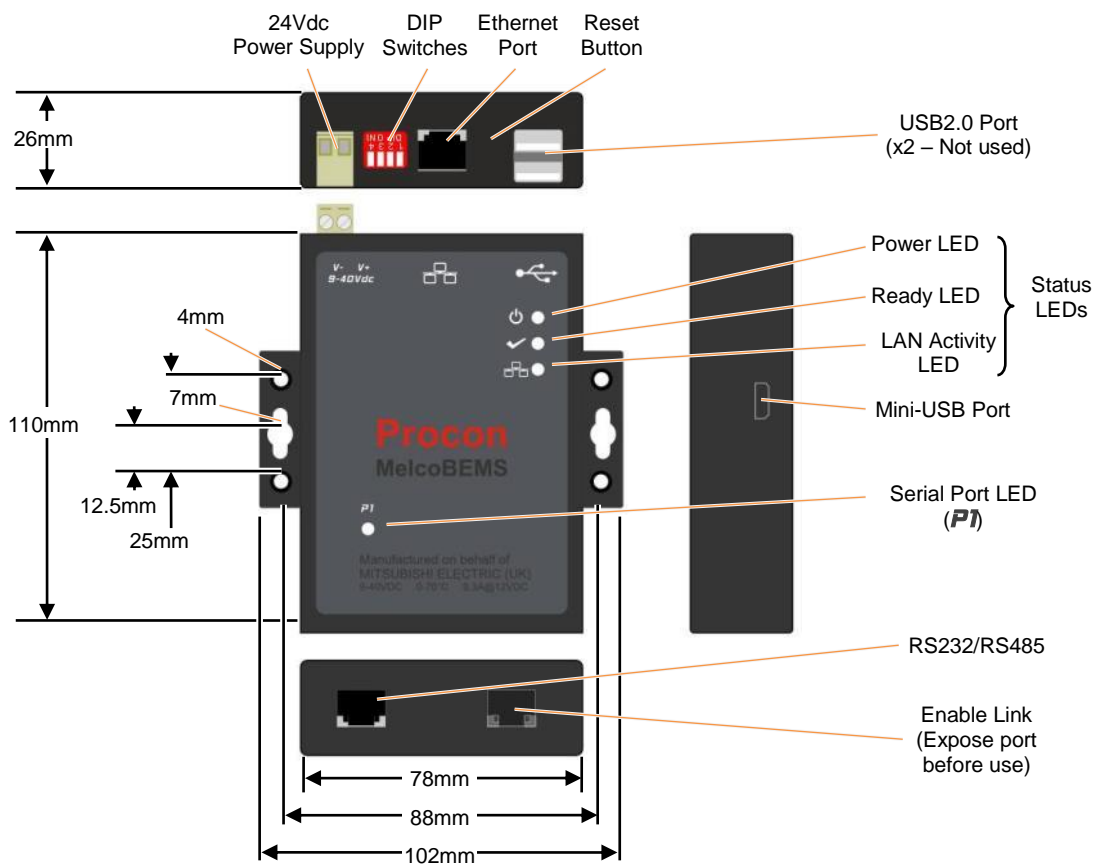

3

[Fig. 3]
Wiring Diagram

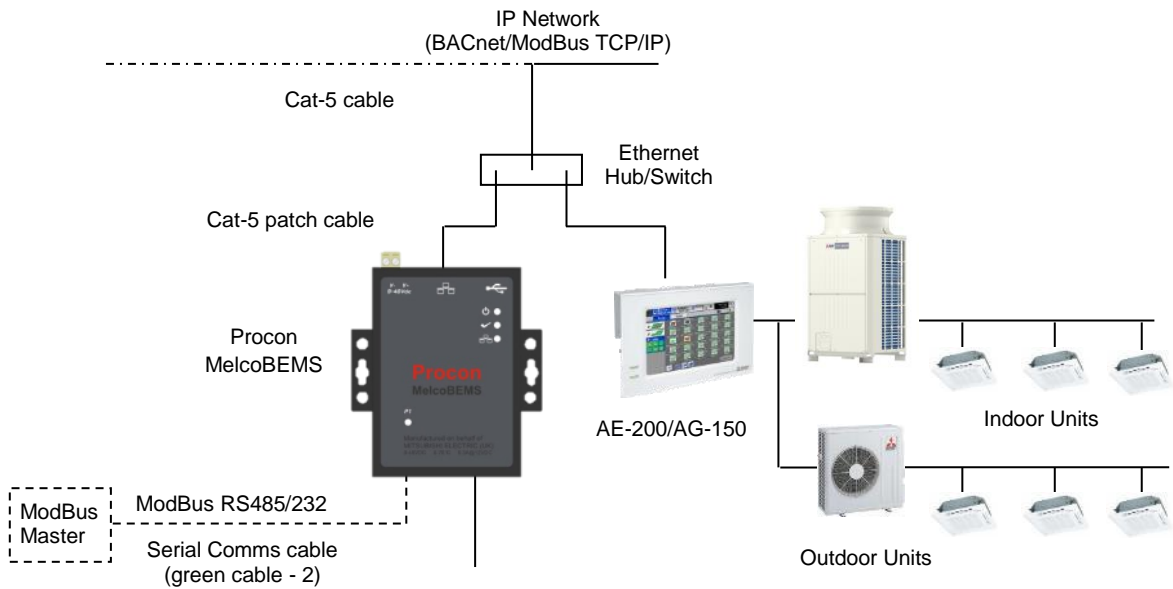

Quick Set Up

Step 1:

Check that the following items are included within the MelcoBEMS packaging before installation.

No.	Part	Quantity
1	Procon MelcoBEMS	1
2	RS232/RS485 Serial Comms cable (green)	1
3	Fire Alarm enable link cable (red)	1
4	Din-Rail Mounting Kit - Clips	2
5	Din-Rail Mounting Kit - Self-Tapping Screws for Din-Rail Clips	4

Step 2:

Establish the MelcoBEMS for either Modbus or BACnet connection. To do so, you need to access the Webpages <http://192.168.1.11>, Username: Admin, Password: password. You also need to enter the centralised controller (AE-200/AG-150 for instance) IP address.

Step 3:

If using Modbus ensure that the correct DIP switches are set for Modbus BMS communicating via RS232/RS485 as below.

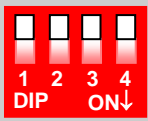
	Switch No. (SW1)	RS232 Signal	RS422 Signal	RS485 Signal
	1 (SW1:p1)	ON	OFF	OFF
	2 (SW1:p2)	ON	ON	OFF
	3 (SW1:p3)	N/A	N/A	N/A
	4 (SW1:p4)	N/A	N/A	N/A

Step 4:

Connect a 24v DC power supply (field supplied) to the MelcoBEMS.

Step 5:

Connect the MelcoBEMS to the centralised controller using a network cable via a hub/switch (field supplied).

Step 6:

Connect if required the fire alarm using the red cable (supplied with the unit) this is a normally-closed volt-free contact.

Step 7:

Check that the groupings set up in the centralised controller are correct before connecting Modbus or BACnet BMS system (see relevant sections within this document).

Step 8:

Check that the relevant PIN code on the centralised controller has been registered to activate the Ethernet port communication, the MelcoBEMS will not be able to communicate otherwise. See important notes for more details.

Step 9:

Switch the MelcoBEMS on the 'Ready' led should now be lit.

Step 10:

Configure either the Modbus registers via the serial comms interface using Modbus RTU on RS232 or RS485, or via the network interface using Modbus/TCP.

The BACnet points can be accessed via the network interface using BACnet/IP supervisor.

1. Safety precautions

- **Before installing the unit, make sure you read all the "Safety precautions"**
- **The "Safety precautions" provide very important points regarding safety. Make sure you follow them**

Symbols used in the text

Warning:

Describes precautions that should be observed to prevent danger of injury or death to the user.

Caution:

Describes precautions that should be observed to prevent damage to the unit.

-  **Warning:**
Carefully read the labels affixed to the main unit

Warning:

- **Ask the dealer or an authorised technician to install the unit**
 - Improper installation by the user may result in water leakage, electric shock, or fire
- **Use the specified cables for wiring. Make the connections securely so that any outside forces acting on the cables are not applied to the terminals**
 - Inadequate connection and fastening may generate heat and cause a fire
- **Never repair the unit. If the controller must be repaired, consult the dealer**
 - If the unit is repaired improperly, electric shock, or fire may result
- **When handling this product, always wear protective equipment. EG: Gloves, full arm protection and safety glasses**
 - Improper handling may result in injury
- **Have all electric work done by a licensed electrician according to "Electric Facility Engineering Standard", "Interior Wire Regulations" and the instructions given in this manual and always use a special circuit**
 - If the power source capacity is inadequate or electric work is performed improperly, electric shock and fire may result
- **Keep the electric parts away from any water - washing water etc...**
 - Contact may result in electric shock, fire or smoke
- **Do not reconstruct or change the settings of the protection devices**
 - If the protection device is shorted or operated forcibly, or parts other than those specified by Mitsubishi Electric are used, fire or explosion may result
- **To dispose of this product, consult your dealer**

Caution:

- **Ground the unit**
 - Do not connect the ground wire to gas or water pipes, lightning rods, or telephone ground lines. Improper grounding may result in electric shock
- **Install the power cable so that tension is not applied to the cable**
 - Tension may cause the cable to break and generate heat which may, in turn, cause fire
- **Install a leak circuit breaker, as required**
 - If a leak circuit breaker is not installed, electric shock may result
- **Use power line cables of sufficient current carrying capacity and rating**
 - Cables that are too small may leak, generate heat, and cause a fire
- **Use only a circuit breaker and fuse of the specified capacity**
 - A fuse or circuit breaker of a larger capacity or a steel or copper wire may result in a general unit failure or fire
- **Be careful that the installation base is not damaged**
 - If the damage is left uncorrected, the unit may fall and cause personal injury or property damage
- **Safely dispose of the packing materials**
 - Packing materials, such as nails and other metal or wooden parts, may cause stabs or other injuries
 - Tear apart and throw away plastic packaging bags so that children will not play with them - If children play with a plastic bag which has not been torn apart, they face the risk of suffocation

2. Overview

The Mitsubishi Procon MelcoBEMS allows either a Modbus or BACnet building management system (BMS) to monitor and control air-conditioning units attached to a Mitsubishi Electric GB-50ADA, EB50, AG-150A (referred to as 'AG-150A' from now on) or AE-200 central controller.

The Modbus registers can be accessed via the serial comms interface using Modbus RTU on RS232 or RS485, or via the network interface using Modbus/TCP. The BACnet points can be accessed via the network interface using BACnet/IP supervisor.

Depending on the air-conditioning configuration within the AE-200/AG-150A, up to 50 groups can be monitored/controlled. The error state of up to 50 OC/BC units can also be monitored.

Figure 1 shows the items included with the MelcoBEMS.

Figure 2 shows the outside of the unit.

Figure 3 shows the wiring diagram of the unit.

2.1. Overview when using an EB50

The EB50 can be used instead of the AE-200/AG-150.

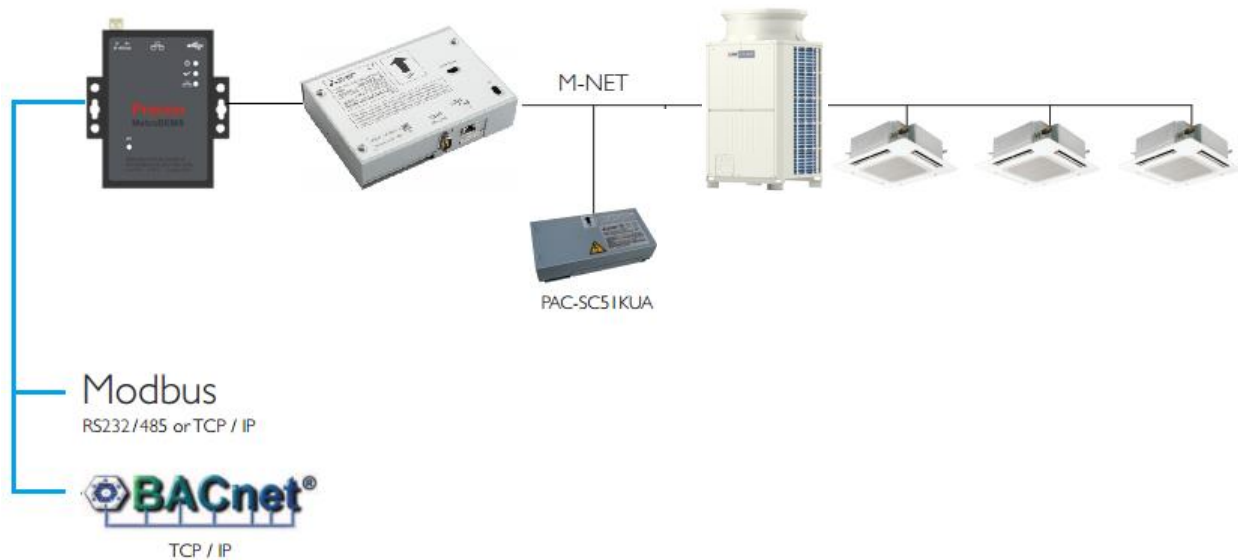

2.2. Overview when using an EB50 with Energy Monitoring

When the MelcoBEMS is connected to the EB50, the EB50 energy monitoring data can be seen on the Modbus or BACnet BEMS network.

It is important to activate the AE-200/AG-150-Energy PIN code on the EB50 to allow energy monitoring. At least one PAC-YG60MCA must be connected to the EB50 to allow the EB50 to monitor pulses from the field supplied energy meter.

The BEMS will be able to monitor two different points:

- Previous Day Energy (kWh)
- Previous Month Energy (kWh)

The MelcoBEMS does not log the energy data. It is down to BEMS to monitor and log the data every day or every month.

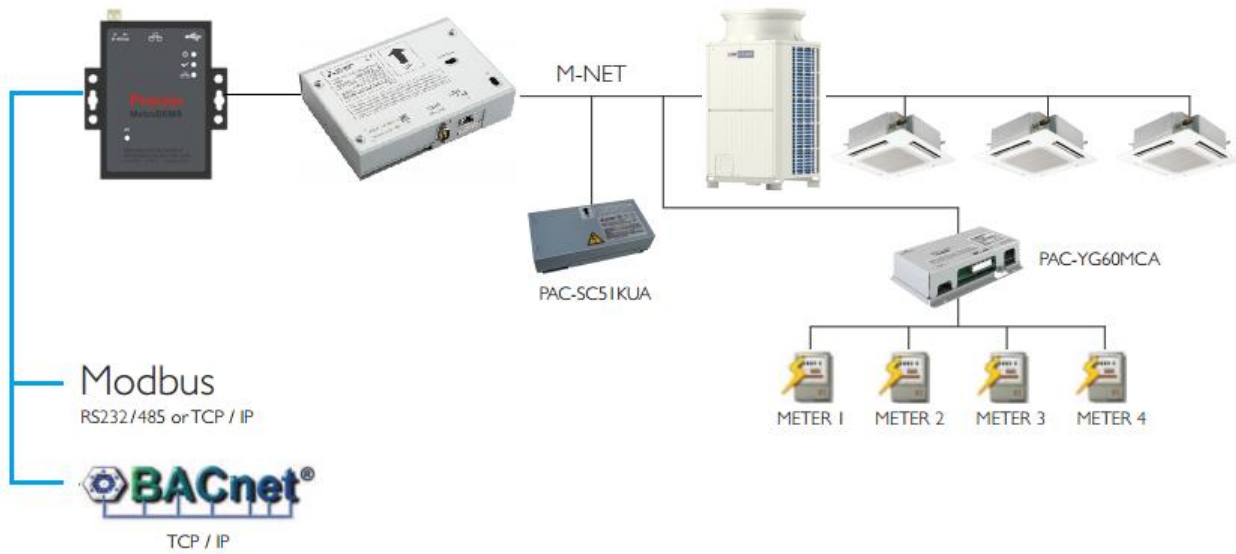

Important note:

The energy monitoring data is calculated by the EB50.

The MelcoBEMS requests daily data every day at 00:05 for the previous day and monthly data at 00:15 on the first day of the month for the previous month. Monthly and daily data are also requested on power up.

For more information about air conditioning energy monitoring, refer to the EB50 manuals.

3. Size and weight

The panel details are:

- Height 110mm
- Width 102mm
- Depth 26mm
- Weight 350g

4. Getting Started

4.1. Unpacking

The Procon MelcoBEMS is supplied with the following components:

No.	Part	Quantity
1	Procon MelcoBEMS	1
2	RS232/RS485 Serial Comms cable (green)	1
3	Fire Alarm enable link cable (red)	1
4	Din-Rail Mounting Kit - Clips	2
5	Din-Rail Mounting Kit - Self-Tapping Screws for Din-Rail Clips	4

Please contact your supplier if any of these components are missing.

4.2. Before Switching On

Please carefully read the Installation section 5. Before switching the unit on, please check all connections are secure.

The unit does not come with a power supply. The Procon MelcoBEMS is normally powered with 12 or 24Vdc, but works with voltage ranges from 9 up to 40 Vdc regulated, 300mA@12Vdc, 150mA@24Vdc.

5. Installation

5.1. Selecting an Installation Site

- Avoid locations in direct sunlight
- Avoid locations exposed to steam or oil vapour
- Avoid locations where combustible gas may leak, settle or be generated
- Avoid installation near machines emitting high-frequency waves
- Avoid places where acidic solutions are frequently handled
- Avoid places where sulphur-based or other sprays are frequently used
- Avoid areas of high humidity
- Install inside the building
- Install near the connected indoor units

5.2. Installation

5.2.1. Physical unit installation

The Procon MelcoBEMS has DIN Rail mounts on the bottom of the unit. Please secure the Procon MelcoBEMS before powering the unit on.

5.2.2. Power supply

⚠ Warning:

Electrical work should be done by qualified electrical engineers / electrician in accordance with "Engineering Standards for Electrical Installation" and supplied installation manuals. Dedicated circuits should also be used. If the power circuit lacks capacity or has an installation failure, it may cause a risk of electric shock or fire.

The Procon MelcoBEMS does not come with a power supply. Please purchase a power supply with the following specifications and attach the plug to the Procon MelcoBEMS power in.

- 12 or 24Vdc regulated. 300mA@12Vdc, 150mA@24Vdc.

⚠ Caution:

Do not use anything other than the correct capacity breaker and fuse. Using fuse, wire or copper wire with too large capacity may cause a risk of malfunction or fire.

- Be sure to take power from the special branch circuit
- Install the unit to prevent any of the control circuit cables coming into direct contact with power cables
- Ensure that there is no slack on all wire connections
- Never connect the power cable to leads for the transmission cables. This will damage the transmission cables

5.2.3. Connection Details

All electrical work should be carried out by a competent person and wiring must be in accordance with the national electrical installation regulations.

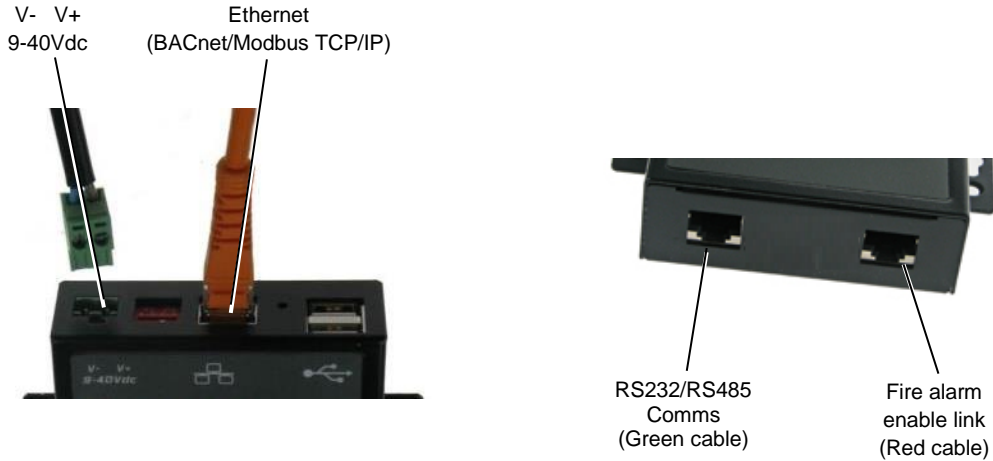

5.3. Ethernet

The Procon MelcoBEMS is a 10/100Base-T device and needs to be connected to the centralised controller and either the Modbus TCP/IP or BACnet/IP network. Fig. 3 shows the use of a hub/switch (not supplied) to make the connections, but this unit and the centralised controller could just as easily be connected directly to the Modbus TCP/IP master or BACnet/IP supervisor.

See Section 7.2.6 for Port Configurations (Modbus Only).

Note The Procon MelcoBEMS and the centralised controller require separate IP addresses which must be on the same subnet. The Modbus Slave option does not support Auto-Negotiation.

5.4. Initial Power On

Once all above has been carried out, apply power to the unit. The power indicator on the front panel will light up to indicate that it has started.

When power is first applied MelcoBEMS will attempt to find the number of groups setup on the centralised controller. Once successful the unit can be commissioned (see section 6).

5.5. Status Indicators

The status indicators have the following functions:

Indicator	Description
Power	On constantly – MelcoBEMS is powered up. Off – there is no power to MelcoBEMS
Ready	On constantly – The MelcoBEMS is ready to communicate over Modbus or BACnet Off constantly – The MelcoBEMS is not ready to communicate (Failed to boot)
Serial port	Blinks when there is activity on the Serial ports

6. Configuration, Fire Alarm enable link and Webpages settings

6.1. Air-Conditioning Group Configuration

The groupings set up in the centralised controller determine which unit addresses can accept commands from the Modbus or BACnet BMS system. The group number is defined as 'the lowest indoor unit address within the group'. This then becomes the 'master' address for the group, and is the only address within that group than can accept commands.

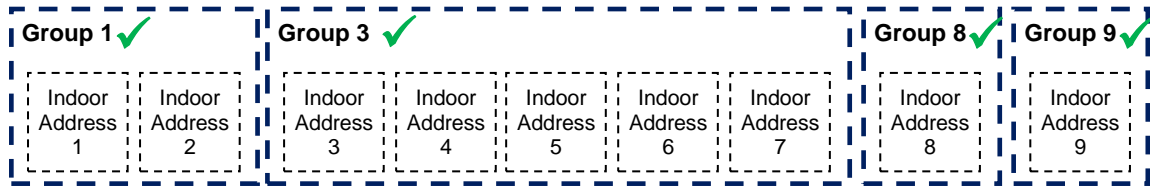

Valid 'Indoor Unit'/'Group' addressing

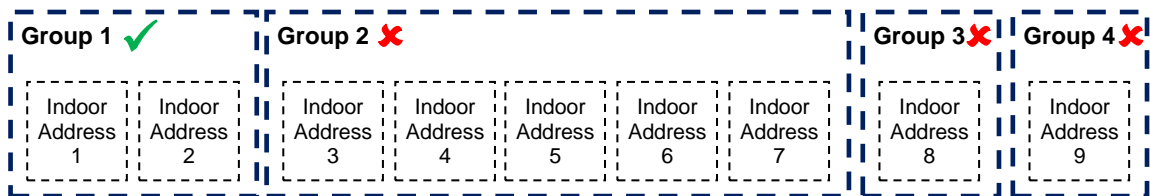

Invalid 'Indoor Unit'/'Group' addressing

The other units within a group can be classed as 'slave' units and contain the same status parameter values as the 'master', apart from the Error Code, which is unique to each unit.

In the example above, addresses 01, 03, 06 and 08 are the 'master' units, and 02, 04, 05 and 07 are the 'slave' units.

Note: Attempting to write a command to a 'slave' unit will have no effect.

6.2. Unit operation

At startup and provided a IP network cable is attached (the '  ' led should be lit), the Procon MelcoBEMS unit attempts to establish a connection with the centralised controller using the appropriate IP address.

Note The Modbus Global Parameter or BACnet System Object 'G50 Comms State' can be read via Modbus master or BACnet Supervisor to determine if the Procon MelcoBEMS unit is communicating with the centralised controller.

Once established, the centralised controller is interrogated to determine the number of active groups. At this point the Procon MelcoBEMS unit begins its polling, sequence, requesting the MNet status, the status of all active groups, and the list of all current alarms. This sequence is continually repeated, with new control settings from the BMS transmitted to the centralised controller by interleaving into the poll sequence.

Note The time required to complete the polling sequence will depend on the number of active groups programmed in the centralised controller and the frequency of new control settings sent via the BMS.

If the BMS is using Modbus RS232 or RS485 and provided a valid Modbus message is received, then the two (yellow - incoming, and green - outgoing) colour 'P1' led will light to indicate valid Modbus communications. If Modbus/TCP or BACnet/IP is being used then there will be increased activity from the '  ' led.

6.3. Fire Alarm enable link

The Fire Alarm enable link allows a normally-closed volt-free contact to set or reset the 'Forced-Off' feature in the centralised controller. While the 'Forced-Off' feature is enabled, all units connected to the centralised controller are switched off and all remote-controllers are disabled.

Upon detection of the closed contact, the Procon MelcoBEMS unit sends the 'Forced-Off' Set command to the centralised controller, and resends at 5 seconds intervals while the contact is open.

As soon as the contact opens, the Procon MelcoBEMS unit sends the 'Forced-Off' Reset command to the centralised controller once only. This ensures that any subsequent 'Forced-Off' commands sent via the BACnet BMS system are not overridden.

Note The Procon MelcoBEMS comes supplied with an Fire Alarm enable link (red) cable. If necessary, connect the red cable (pin 2 and pin 7) between 'P4' and terminals in an enclosure. The fire alarm settings must be set on the MelcoBEMS settings using the webpages.

6.4. Reset Button

The Reset button simply performs a software reboot, reloading any current configuration.

6.5. Time clock

The time is synchronised from the centralised controller at the MelcoBEMS start up and about every 10 -15 minutes.

It is important to set the time properly on the centralised controller especially when using energy monitoring as the energy data is read from the centralised controller at 01:05 for daily data and 01:15 for monthly data. 01:30 BACnet Trendlogs

6.6. Centralised Controller Group Configuration Learning

The MelcoBEMS automatically downloads the group settings from the centralised controller. This is done at start up and every 10 minutes.

For instance, if 10 groups are setup on the centralised controller, the MelcoBEMS will pick up those 10 groups only.

The group name set up on the centralised controller will also be picked up by the MelcoBEMS and those names can be activated on the BACnet server. Refer to the BACnet section for more details.

Note If the names of the centralised controller are changed while the MelcoBEMS is running, the new names will be picked up and this may have an effect on the BACnet side.

6.7. Webpages Settings

The MelcoBEMS Modbus and BACnet settings are configurable using Webpages.

The default link is <http://192.168.1.11>.

6.7.1. Landing page

It is required to login. The username is **Admin** and password is **password**.

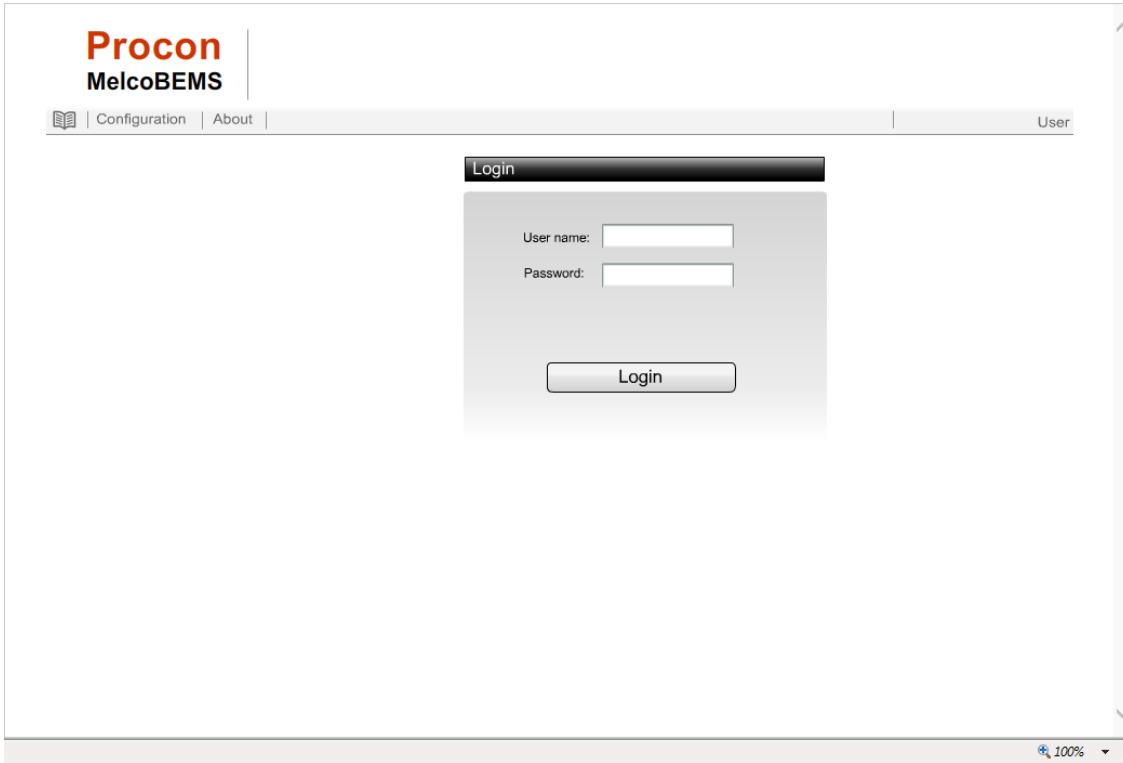

Two options are available, IP settings and Comms settings.

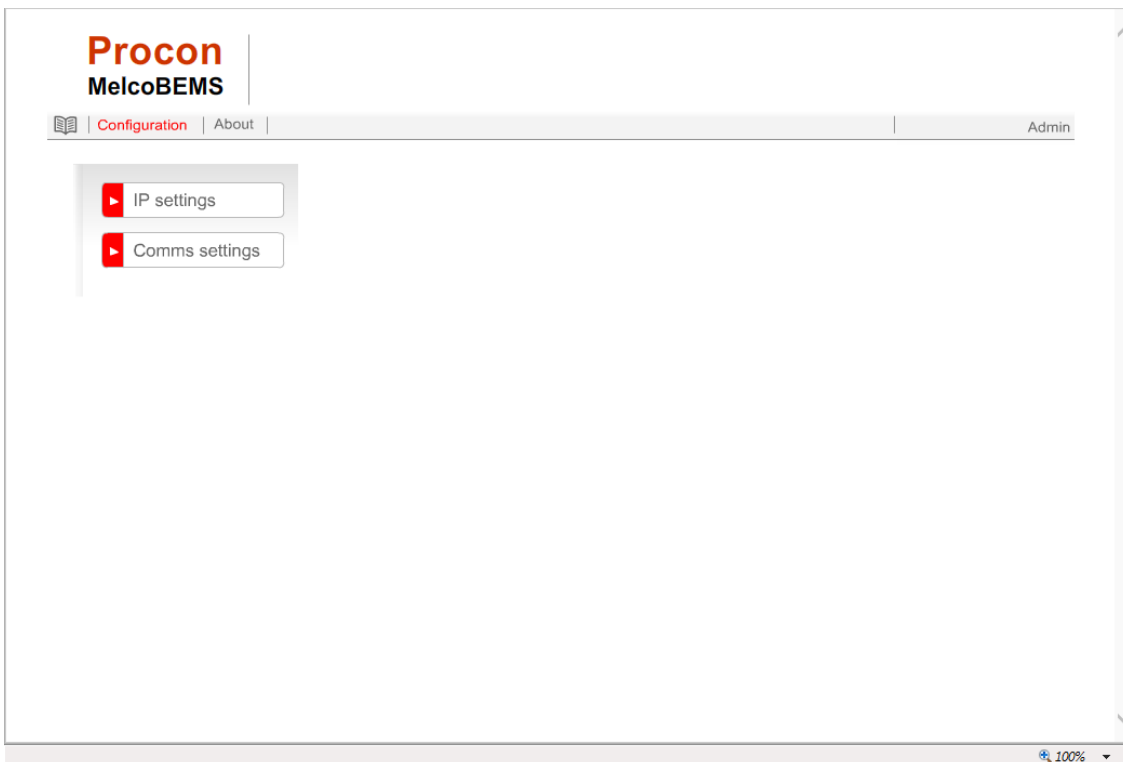

6.7.2. IP address

The IP address of MelcoBEMS can be changed by going to IP settings.

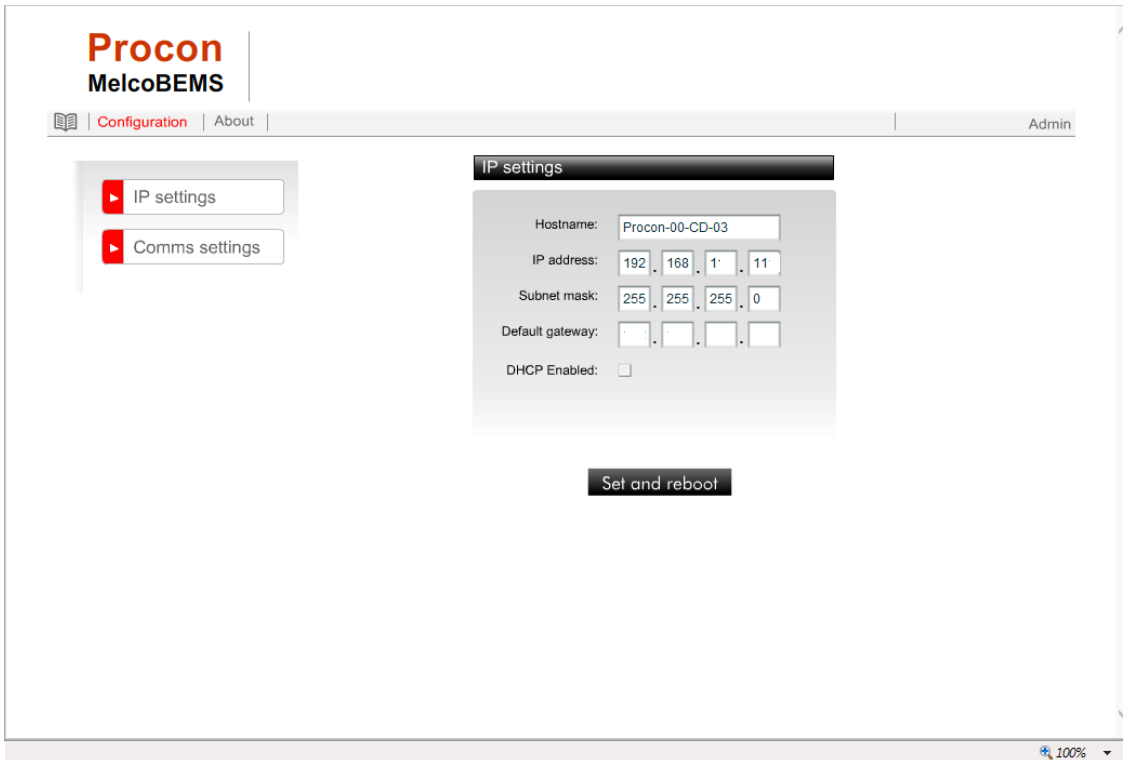

6.7.3. Modbus and BACnet settings

The Modbus and BACnet settings are configurable by going to comms settings.

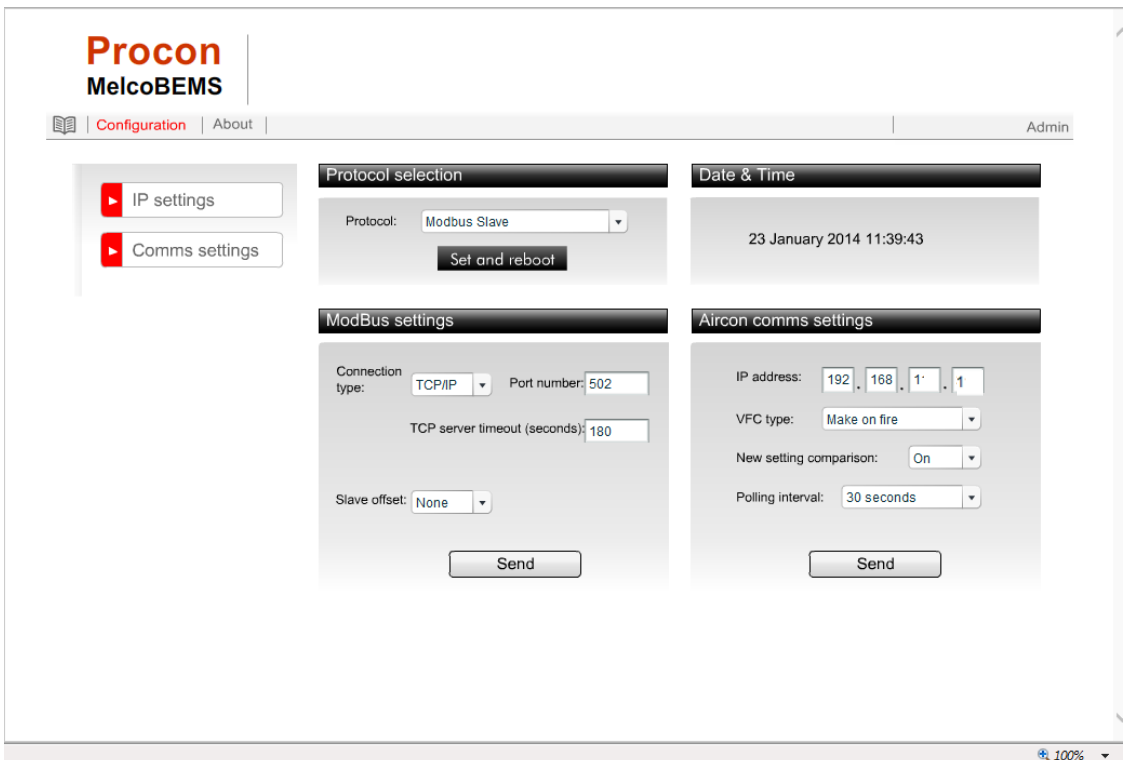

To activate Modbus, select the Protocol to Modbus Slave and click “Set and Reboot”. The MelcoBEMS takes up to 1min to reboot.

Select the Connection type: RS232/485 or TCP/IP. When changing between RS232 and RS 485 don't forget to make sure dip switches are in correct position, see Section 7.2.5 for more details.

Aircon comms settings is used to enter the centralised controller address and activate the fire alarm.

When the settings are completed, click on “Send”.

The screenshot displays the Procon MelcoBEMS Configuration web interface. At the top left, the logo 'Procon MelcoBEMS' is visible. Below it, there are navigation tabs for 'Configuration', 'About', and 'Admin'. On the left side, there is a sidebar with two main menu items: 'IP settings' and 'Comms settings', each with a red play button icon. The main content area is divided into four panels:

- Protocol selection:** A dropdown menu is set to 'BACnet Server', and a 'Set and reboot' button is present below it.
- Date & Time:** Displays the current date and time as '23 January 2014 11:41:46'.
- BACnet settings:** Contains several input fields: 'Device instance' (370127), 'BACnet IP port' (47808), 'Device name' (Mitsubishi Interface), 'Location' (Server Room), and 'Labels' (Generic). A 'Send' button is at the bottom.
- Aircon comms settings:** Contains input fields for 'IP address' (192.168.1.1), 'VFC type' (Make on fire), 'New setting comparison' (On), and 'Polling interval' (30 seconds). A 'Send' button is at the bottom.

To activate BACnet, select the Protocol to BACnet Server and click “Set and Reboot”. The MelcoBEMS takes up to 1min to reboot.

The Device Instance, BACnet IP port, Device name and Location may be entered.

The Labels can be set to either Generic and Aircon.

- Generic: The object names will be Group 1, Group 2, Group 3 etc...
- Aircon: The object names will be picked up from the centralised controller at the start up or every 10 minutes

Aircon comms settings is used to enter the centralised controller IP address and activate the fire alarm.

The new setting comparison function allows the MelcoBEMS to write values to the centralised controller only when required. For instance, if the setpoint of the indoor unit 1 is 22°C and the BEMS sends 22°C again, the MelcoBEMS will only write to the centralised controller if the “New setting comparison” is Off. If the “New setting comparison” is On the MelcoBEMS will ignore the BEMS command in that instance.

When the settings are completed, click on “Send”.

6.7.4. Upgrade MelcoBEMS Firmware

The MelcoBEMS firmware version is displayed. The current firmware may periodically require updates, to support additional features and/or functionality.

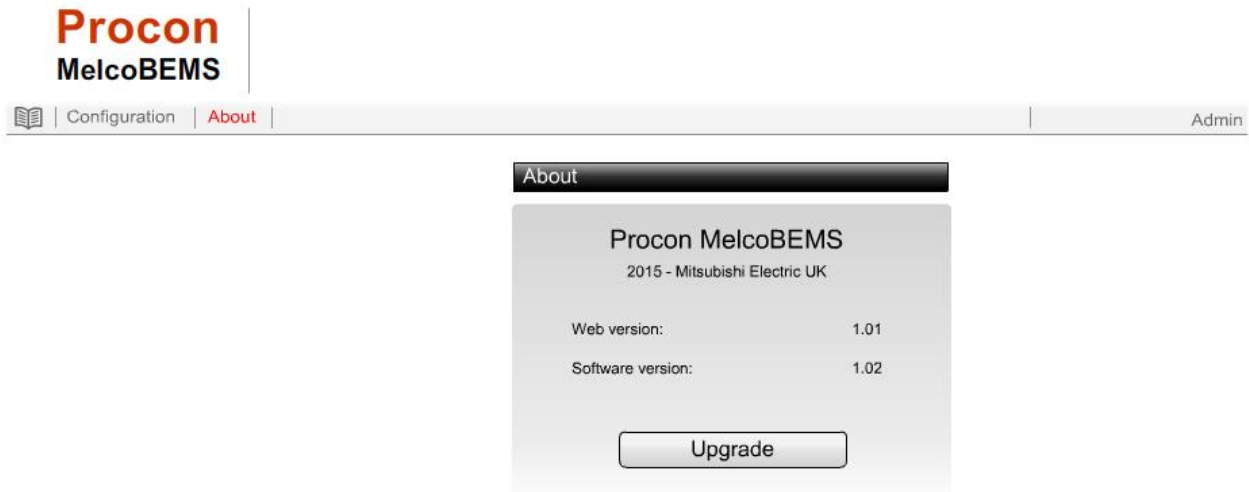

To upgrade the firmware, click 'Upgrade'. A standard 'Open' popup appears. Select the required update file and click 'Open' to confirm selection.

Wait for the MelcoBEMS to restart.

Login and return to the 'About' page to confirm the firmware version has been updated.

7. Modbus

7.1. Serial comms port (Modbus Only)

The 'P1' connector provides access to the Modbus registers using RS232 or 2-wire RS485. The RS232 port configuration is used for point to point Modbus communications.

See Section 7.2.5 and 7.2.7 Port Configurations (Modbus Only).

From Green RJ45 Pin No.	RS232 Signal	RS422 Signal	RS485 Signal
Pin 1 1 (White/Orange)	DSR*	N/A	N/A
2 (Orange)	RTS	TXD+	Data+ (A)
3 (White/Green)	GND	GND	GND
4 (Blue)	TXD	TXD-	Data- (B)
5 (White/Blue)	RXD	RXD+	N/A
6 (Green)	DCD*	RXD-	N/A
7 (White/Brown)	CTS	N/A	N/A
8 (Brown)	DTR*	N/A	N/A

RS232/RS485 Comms Lead Wiring Diagram
The image shows the flat side of RJ45 plug

Note * indicates the signal is only available from Port 2 on RS232

The RS485 interface can be used on a compatible serial communications network shared by multiple RS485 devices. The Slave Address Offset parameter must be set to prevent multiple units using the same slave numbers.

It is recommended that screened twisted-pair cable is used.
RS485-A is the non-inverting signal and is also named RS485+
RS485-B is the inverting signal and is also named RS485-
Common should be connected to the cable screen.

Note RS232 or 2-wire RS485 Signals are determined via the DIP switches. See Section 7.2.7 for Port Configurations (Modbus Only). The Common signal is already connected in the RJ45 so does not need to be connected at the other end.

7.2. Modbus Registers

When the Procon MelcoBEMS is communicating with Modbus BMS the relevant indoor units are displayed as 20

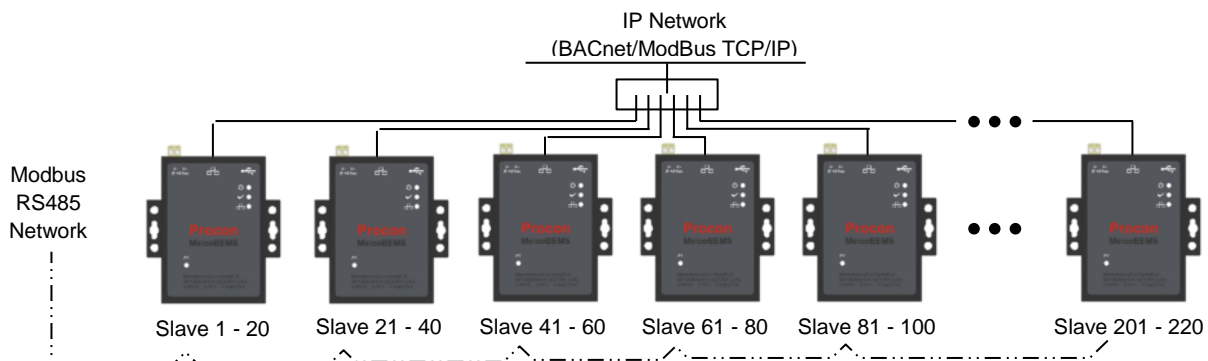

Modbus slaves, each with 60 registers (Offset = 0 to 59).

By default the slave addresses are 1 - 20 but an address offset can be applied to provide ranges 21-40, 41-60, 61-80, 81-100, up to 201-220. ModBus Slave addressing per Procon MelcoBEMS

This is useful to prevent address clashing when the Procon MelcoBEMS is attached to a communications network containing multiple Modbus devices.

The Procon MelcoBEMS maps the data from the air conditioner units into Modbus registers accessed by two Modbus parameters 'Slave No.' and 'Offset'.

All slave numbers referred to in this document assume the default addresses - Add the 'offset' value where applicable.

Slaves 1 to 16 each represent 3 units, and slave 17 represents 2 units, with 'Unit C' of slave 17 used for various system settings. See Modbus Table Overview for details.

Each slave is organised as follows:

General Information			Extended Information			HWCP Information		
Unit A	Unit B	Unit C	Unit A	Unit B	Unit C	Unit A	Unit B	Unit C
Offset 0	Offset 10	Offset 20	Offset 30	Offset 40	Offset 50	Offset 60	Offset 70	Offset 80

General Information for a single unit		Extended Information for a single unit		HWCP Information for a single unit	
Register Offset	Stored Value	Register Offset	Stored Value	Register Offset	Stored Value
0	Return Air Temp	0	Air Direction (Read)	0	Warm Water Mode SP (Read)
1	Error Code	1	Air Direction (Write)	1	Hot Water Mode SP (Read)
2	Setpoint (Read)	2	Inhibit (Read)	2	HWHP Fan Mode (Read)
3	Mode (Read)	3	Inhibit (Write)	3	HWHP Inlet Temp (Read)
4	Fan Speed (Read)	4	Ventilation (Read)	4	HWHP Outlet Temp (Read)
5	Setpoint (Write)	5	Ventilation (Write)	5	HWHP Water Temp (Read)
6	Mode (Write)	6	Filter Reset (Read)	6	HWHP Outdoor Temp (Read)
7	Fan Speed (Write)	7	Filter Reset (Write)	7	Warm Water Mode SP (Write)
8	On/Off (Read)	8	Prev day energy (Read)	8	Hot Water Mode SP (Write)
9	On/Off (Write)	9	Prev month energy (Read)	9	HWHP Fan Mode (Write)

Dual Setpoint Control Information for a single unit			Time/Mode monitoring Information for a single unit		
Unit A	Unit B	Unit C	Unit A	Unit B	Unit C
Offset 90	Offset 100	Offset 110	Offset 120	Offset 150	Offset 180

Dual Setpoint Control Information for a single unit		Time/Mode monitoring Information for a single unit	
Register Offset	Stored Value	Register Offset	Stored Value
0	Cool Setpoint (Read)	0	Unit Cool time previous day (Read)
1	Heat Setpoint (Read)	1	Unit Heat time previous day (Read)
2	Auto Setpoint (Read)	2	Unit On time previous day (Read)
3	Setback cool setpoint (Read)	3	Unit Cool time previous month (Read)
4	Setback heat setpoint (Read)	4	Unit Heat time previous month (Read)
5	Cool Setpoint (Write)	5	Unit On time previous month (Read)
6	Heat Setpoint (Write)	6	Unused
7	Auto Setpoint (Write)	7	Unused
8	Setback cool setpoint (Write)	8	Unused
9	Setback heat setpoint (Write)	9	Unused

Examples: 1) To read the current fan speed of unit 8, the required Modbus message would contain Slave 3, Function 3, Offset 14.

2) To read the current mode of unit 48, the required Modbus message would contain Slave 16, Function 3, Offset 23.

On/Off, Inhibit & Filter Reset can also be accessed via 'Coils'. Each slave contains 18 coils, organised as follows

Coil Offset	Definition	Coil Offset	Definition
0	Unit A On/Off (R)	9	Unit B Inhibit (W)
1	Unit A On/Off (W)	10	Unit C Inhibit (R)
2	Unit B On/Off (R)	11	Unit C Inhibit (W)
3	Unit B On/Off (W)	12	Unit A Filter Reset (R)
4	Unit C On/Off (R)	13	Unit A Filter Reset (W)
5	Unit C On/Off (W)	14	Unit B Filter Reset (R)
6	Unit A Inhibit (R)	15	Unit B Filter Reset (W)
7	Unit A Inhibit (W)	16	Unit C Filter Reset (R)
8	Unit B Inhibit (R)	17	Unit C Filter Reset (W)

The inhibit function works in conjunction with the centralised controller. The function to inhibit must be set on the centralised controller (On/Off, Mode, Setpoint, Filter Reset).

The MelcoBEMS inhibit will then lock those set functions on the remote controller.



7.2.1. OC/BC Error Codes

Slave 18 contains the error codes for units 51 to 80. Slave 19 contains the error codes for units 81 to 100.

7.2.2. Additional Register Usage

Slave	Offset	Setting
17	20	MNet Status (0=Initialising, 1=OK)
17	21	Aircon Status (0=Not found, 1=OK)
17	22	Global Forced-Off (Write – 0=Disabled, 1=Enabled)
17	23	Global Forced-Off (Read – 0=Disabled, 1=Enabled))
17	24	New Setting Comparison (0=Off, 1=On)
19	20	Firmware Number Minor
19	21	Firmware Version Major
19	22-27	MAC Address
20	7-10	IP Address
20	11-14	Gateway Address
20	15-18	Subnet Mask
20	20	Slave Address Offset
20	21	Aircon IP Address

7.2.3. Parameters Settings

Parameter	Settings	Description	
Return Air Temperature	0.0 to 99.9	AC Temperature reading	
Error Code	4 digit error code 8000 = No error	AC or Lossnay unit error code - Error code less than 8000 asserts alarm.	
Setpoint Temperature	Cool/Dry Heat Auto	19°C to 30°C 17°C to 28°C 19°C to 28°C	Air Conditioner Setpoint
	Heating Eco-Heating Hot-Water Anti-Freeze Cooling	30°C to 45°C 30°C to 45°C 30°C to 70°C 10°C to 45°C 10°C to 30°C	
Setpoint Temperature 1	25°C to 70°C	HWHP Only	
Setpoint Temperature 3	25°C to 70°C	HWHP Only	
Inlet Temperature	-99.9°C to 99.9°C	PWFY-BU Only	
Operation Mode	Fan (Draft) Cool Heat Dry Auto Not used	0 1 2 3 4 5	AC operation mode
	AutoCool AutoHeat	6* 7*	
	Heat Recovery LC_Auto Bypass	8 9 10	Lossnay unit Only operation mode
	Heating Eco-Heating Hot-Water Anti-Freeze Cooling	11 12 13 14 15	
	Setback Setback Heat Setback Cool	16 17 18	AC operation mode
	Fan Speed	Low Mid2 (low medium) Mid1 (high medium) High Auto	
On/Off	Off On	0 1	AC or Lossnay unit on/off control
Air Direction	Horizontal Mid Mid2 Vertical Swing	0 1 2 3 4	AC Louvre Position
	Local Inhibit	Not Inhibited Inhibited	
Ventilation	Off Low High	0 1 2	
	Filter Sign	Filter Sign Off Filter Sign On	
Error Sign	Off On	0 1	

Parameter	Settings		Description
Fan Mode	Normal Snow	0 1	HWHP Only
Inlet Temperature	0°C to 99.9°C		HWHP Only
Outlet Temperature	0°C to 99.9°C		HWHP Only
Head Temperature	0°C to 99.9°C		HWHP Only
Outdoor Temperature	0°C to 99.9°C		HWHP Only
OC/BC Error Code	4 digit error code 8000 = No error		Error signal - Error code less than 8000 asserts alarm.
MNet Status	Initialising OK	0 1	See Section 7.2.8
G50 Comms State	Not found OK	0 1	See Section 7.2.8
Global Forced-Off	Disabled Enabled	0 1	See Section 7.2.8

7.2.4. Modbus Table Overview

Unit Address	Slave Address	General Info Base Offset	Extended Info Base Offset	Coil Base Offsets		
				On/Off	Inhibit	Filter Sign
1	1	0	30	0	6	12
2	1	10	40	2	8	14
3	1	20	50	4	10	16
4	2	0	30	0	6	12
5	2	10	40	2	8	14
6	2	20	50	4	10	16
7	3	0	30	0	6	12
8	3	10	40	2	8	14
9	3	20	50	4	10	16
10	4	0	30	0	6	12
11	4	10	40	2	8	14
12	4	20	50	4	10	16
13	5	0	30	0	6	12
14	5	10	40	2	8	14
15	5	20	50	4	10	16
16	6	0	30	0	6	12
17	6	10	40	2	8	14
18	6	20	50	4	10	16
19	7	0	30	0	6	12
20	7	10	40	2	8	14
21	7	20	50	4	10	16
22	8	0	30	0	6	12
23	8	10	40	2	8	14
24	8	20	50	4	10	16
25	9	0	30	0	6	12
26	9	10	40	2	8	14
27	9	20	50	4	10	16
28	10	0	30	0	6	12
29	10	10	40	2	8	14
30	10	20	50	4	10	16
31	11	0	30	0	6	12
32	11	10	40	2	8	14
33	11	20	50	4	10	16

Unit Address	Slave Address	General Info Base Offset	Extended Info Base Offset	Coil Base Offsets		
				On/Off	Inhibit	Filter Sign
34	12	0	30	0	6	12
35	12	10	40	2	8	14
36	12	20	50	4	10	16
37	13	0	30	0	6	12
38	13	10	40	2	8	14
39	13	20	50	4	10	16
40	14	0	30	0	6	12
41	14	10	40	2	8	14
42	14	20	50	4	10	16
43	15	0	30	0	6	12
44	15	10	40	2	8	14
45	15	20	50	4	10	16
46	16	0	30	0	6	12
47	16	10	40	2	8	14
48	16	20	50	4	10	16
49	17	0	30	0	6	12
50	17	10	40	2	8	14

7.2.5. Special Function Descriptions

This section describes functions necessary for the Modbus BMS communicating via RS232/RS485.

The DIP switches at the top of the Procon MelcoBEMS determine the use of RS232 or RS485. Switch 3 (SW1:p3) and switch 4 (SW1:p4) are not supported.

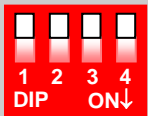
	Switch No. (SW1)	RS232 Signal	RS422 Signal	RS485 Signal
	1 (SW1:p1)	ON	OFF	OFF
	2 (SW1:p2)	ON	ON	OFF
	3 (SW1:p3)	N/A	N/A	N/A
	4 (SW1:p4)	N/A	N/A	N/A

7.2.6. Floating points and decimal points on temperatures

The room temperature and the setpoint can be set with decimal points to read for instance 22.4°C.

To read the temperature or setpoint with decimal points 8000 must be added to the normal register (32Bit Float IEEE).

Formula:

$(16 \text{ bit register} * 2) - 1 + 8000$

Example:

16 bit register	32Bit Float IEEE
1	8001
2	8003
3	8005
.	
.	
.	
10	8019
11	8021

7.2.7. Port Configurations (Modbus Only)

Ethernet Network interface

- Modbus/TCP
- TCP port 502

RS232/RS485 interface (*P1* only)

- Modbus RTU
- 9600 baud, 8 data bits, no parity, 1 stop bit

Modbus Functions accepted

- Fn 1 Read Coils
- Fn 3 Read Holding Registers
- Fn 5 Write Single Coil
- Fn 6 Write Single Register
- Fn 16 Write Multiple Registers

Modbus Datatypes supported

- Supports (MSB first) datatype ranges

7.2.8. Modbus Global Parameters

Global Parameter	Settings		Description
MNet Comms State	M-Net Initialising	0	Provides an indication of the communication status between the AG-150A and the Mitsubishi M-Net network
	M-Net OK	1	
Note	While M-Net is initialising, the air-conditioning is effectively offline to control and monitoring requests.		
G50 Comms State	AG-150A not responding	0	Provides an indication of the communication status between the Procon MelcoBEMS and the AG-150A.
	AG-150A comms OK	1	
Note	'AG-150A not responding' either means the AG-150A is switched off or is not connected to the network.		
Global Forced-Off	Enables and disables the Global Forced-Off command. This setting allows the BMS to provide functionality equivalent to the 'Fire Alarm enable link' described in Fire Alarm enable link section		

8. BACnet

8.1. Specification

When the Procon MelcoBEMS is setup to communicate via the BACnet/IP network it is ANSI/ASHRAE Standard 135-2004 compatible or latest equivalent.

Property	Setting
Segmentation	Not supported
Maximum APDU length supported	1476 Octets
Object List	Supported
Device ID	User configurable
Device Name	User configurable
Object Names	User configurable via 'Labels' option (Comms settings)

8.2. Object Types

Object Types			Service List	
Object Type		Supported	Supported Services	
Analog Input	0	Yes	Read Property	12
Analog Output	1	Yes	Read Property Multiple	14
Analog Value	2		Write Property	15
Binary Input	3	Yes		
Binary Output	4	Yes	Who-Has	33
Binary Value	5	Yes	I-Have	27
Calendar	6		Who-Is	34
Command	7		I-Am	36
Device	8	Yes		
Event Enrolment	9			
File	10			
Group	11			
Loop	12			
Multi-State Input	13	Yes		
Multi-State Output	14	Yes		
Notification Class	15			
Program	16			
Schedule	17			
Averaging	18			
Multi-State Value	19			
Trend Log	20	Yes		

8.3. Object List

Object	Object Type	Instance No.	Settings
On/Off (Setup)	Binary Output	1xxx01	Inactive Off Active On
On/Off (State)	Binary Input	1xxx02	Inactive Off Active On
Error Code	Analog Input	1xxx03	4 digit error code 8000 = No error (includes BACnet property - Description showing unit model)
Operation Mode (Setup)	Multi-State Output	1xxx04	Cool 1 Dry 2 Fan 3 Heat 4 Auto 5 Heat Recovery* 6 LC_Auto* 7 Bypass* 8 AutoHeat** 9 AutoCool** 10 Heating*** 11 Eco-Heating*** 12 Hot-Water*** 13 Anti-Freeze*** 14 Cooling*** 15 Setback 16 Setback Heat 17 Setback Cool 18
Note * - Lossnay Only. ** - Not settable. *** - Heat pump boiler only.			
Operation Mode (State)	Multi-State Input	1xxx05	Cool 1 Dry 2 Fan 3 Heat 4 Auto 5 Heat Recovery* 6 LC_Auto* 7 Bypass* 8 AutoHeat 9 AutoCool 10 Heating*** 11 Eco-Heating*** 12 Hot-Water*** 13 Anti-Freeze*** 14 Cooling*** 15 Setback 16 Setback Heat 17 Setback Cool 18
Note * - Lossnay Only. *** - Heat pump boiler only.			
Fan Speed (Setup)	Multi-State Output	1xxx06	Low 1 Mid2 (low medium) 2 Mid1 (high medium) 3 High 4 Auto 5
Fan Speed (State)	Multi-State Input	1xxx07	Low 1 Mid2 (low medium) 2 Mid1 (high medium) 3 High 4 Auto 5

Object	Object Type	Instance No.	Settings
Room Temperature	Analog Input	1xxx08	
Setpoint Temperature (Setup)	Analog Output	1xxx09	Cool/Dry 19°C to 30°C Heat 17°C to 28°C Auto 19°C to 28°C
Setpoint Temperature (State)	Analog Input	1xxx10	Cool/Dry 19°C to 30°C Heat 17°C to 28°C Auto 19°C to 28°C
Filter Sign (State)	Binary Input	1xxx11	Inactive Sign Off Active Sign On
Filter Sign (Setup)	Binary Output	1xxx12	Inactive Clear Sign Active No Action
Local Inhibit (Setup)	Binary Output	1xxx13	Inactive Off Active Inhibit
Local Inhibit (State)	Binary Input	1xxx14	Inactive Off Active Inhibited
Air Direction (Setup)	Multi-State Output	1xxx15	Horizontal 0 Mid 1 Mid2 2 Vertical 3 Swing 4
Air Direction (State)	Multi-State Input	1xxx16	Horizontal 0 Mid 1 Mid2 2 Vertical 3 Swing 4
Ventilation (Setup)	Multi-State Output	1xxx17	Off** 0 Low** 1 High** 2
Note ** - Lossnay/OA units Only.			
Ventilation (State)	Multi-State Input	1xxx18	Off** 0 Low** 1 High** 2
Note ** - Lossnay/OA units Only.			
Prev Day Energy (kWh)	Analog Input	1xxx19	
Prev Month Energy (kWh)	Analog Input	1xxx20	
Unused		1xxx21	
OC/BC Error Code	Analog Input	1yyy22	4 digit error code 8000 = No error (includes BACnet property – Description showing unit model)
MNet Comms State	Binary Input	100023	Inactive Init Active OK
System Forced Off (Setup)	Binary Output	100024	Inactive Off Active On
System Forced Off (State)	Binary Input	100025	Inactive Off Active On
G50 Comms State	Binary Input	100026	Inactive Error Active OK
New Setting Compare	Binary Value	100027	Inactive Off Active On
Inlet Water Temperature	Analog Input	1xxx31	
Outlet Water Temperature	Analog Input	1xxx32	
Water Temperature	Analog Input	1xxx33	
Outdoor Unit Temperature	Analog Input	1xxx34	
Warm Water Setpoint Write	Analog Output	1xxx35	
Warm Water Setpoint Read	Analog Input	1xxx36	

Object	Object Type	Instance No.	Settings
Hot Water Setpoint Write	Analog Output	1xxx37	
Hot Water Setpoint Read	Analog Input	1xxx38	
Fan Mode Write	Binary Output	1xxx39	
Fan Mode Read	Binary Input	1xxx40	
Unit Cool time previous day	Analog Input	1xxx41	
Unit Heat time previous day	Analog Input	1xxx42	
Unit On time previous day	Analog Input	1xxx43	
Unit Cool time previous month	Analog Input	1xxx44	
Unit Heat time previous month	Analog Input	1xxx45	
Unit On time previous month	Analog Input	1xxx46	
Cool Setpoint Read	Analog Input	1xxx66	
Heat Setpoint Read	Analog Input	1xxx67	
Auto Setpoint Read	Analog Input	1xxx68	
Setback cool setpoint Read	Analog Input	1xxx69	
Setback heat setpoint Read	Analog Input	1xxx70	
Cool Setpoint Read	Analog Output	1xxx66	
Heat Setpoint Read	Analog Output	1xxx67	
Auto Setpoint Read	Analog Output	1xxx68	
Setback cool setpoint Read	Analog Output	1xxx69	
Setback heat setpoint Read	Analog Output	1xxx70	
Unit Cool time previous day	Trend logs (Plots)	1xxx41	
Unit Heat time previous day	Trend logs (Plots)	1xxx42	
Unit On time previous day	Trend logs (Plots)	1xxx43	
Unit Cool time previous month	Trend logs (Plots)	1xxx44	
Unit Heat time previous month	Trend logs (Plots)	1xxx45	
Unit On time previous month	Trend logs (Plots)	1xxx46	
Device	Device	zzz	includes Location property

Note xxx = unit group number 001 to 050.
yyy = unit address 051 to 100.
zzz = 1 to 4194302

The inhibit function works in conjunction with the centralised controller. The function to inhibit must be set on the centralised controller (On/Off, Mode, Setpoint, Filter Reset).

The MelcoBEMS inhibit will then lock those set functions on the remote controller.



8.4. Object Name

The BACnet Object name is automatically created as either 'Generic' or 'by Aircon' labels, according to the network equipment.

Object	Object Name - Generic	Object Name – by Aircon
On/Off (Setup)	Grp nnn On Off Wr	The air conditioning network is

On/Off (State)	Grp nnn On Off Rd	interrogated every 10 mins ensuring labels are always up to date.
Error Code	Grp nnn (Unit nn) Error Code	
Operation Mode (Setup)	Operation Mode Wr	
Operation Mode (State)	Operation Mode Rd	
Fan Speed (Setup)	Fan Speed Wr	
Fan Speed (State)	Fan Speed Rd	
Room Temperature	Grp nnn Room Temperature	
Setpoint Temperature (Setup)	Grp nnn Setpoint Temperature Wr	
Setpoint Temperature (State)	Grp nnn Setpoint Temperature Rd	
Filter Sign (State)	Filter Sign Rd	
Filter Sign (Setup)	Filter Sign Wr	
Local Inhibit (Setup)	Local Inhibit Wr	
Local Inhibit (State)	Local Inhibit Rd	
Air Direction (Setup)	Air Direction Wr	
Air Direction (State)	Air Direction Rd	
Ventilation (Setup)	Ventilation Wr	
Ventilation (State)	Ventilation Rd	
Inlet Water Temperature	Inlet Water Temp Rd	
Outlet Water Temperature	Outlet Water Temp Rd	
Water Temperature	Representative W Temp Rd	
Outdoor Unit Temperature	Outdoor Temp Rd	
Warm Water Setpoint (Setup)	Warm Water Setp Wr	
Warm Water Setpoint (State)	Warm Water Setp Rd	
Hot Water Setpoint (Setup)	Hot Water Setp Wr	
Warm Water Setpoint (State)	Hot Water Setp Rd	
Fan Mode (Setup)	Fan Mode Wr	
Fan Mode (State)	Fan Mode Rd	
Prev Day Energy (kWh)	Unit nn Energy Day	
Prev Month Energy (kWh)	Unit nn Energy Month	
MNET Comms State	MNET Comms State	
System Forced Off (Setup)	System Forced Off Wr	
System Forced Off (State)	System Forced Off Rd	
G50 Comms State	G50 Comms State	
New Setting Compare	New Setting Compare	
OC/BC Error Code	As detected	As detected

Changing the 'Labels' options between 'Generic' and 'by Aircon' can take up to 10 mins to relearn the Aircon network.

Note Use the 'Set and reboot' on the 'IP settings' page to speed up relearning the labels.

Only the groups set on the centralised controller will be shown on the BACnet objects.

8.5. System Objects

System Object	Settings		Description
MNet Comms State	M-Net Initialising M-Net OK	Inactive Active	Provides an indication of the communication status between the AG-150A and the Mitsubishi M-Net network
Note	While M-Net is initialising, the air-conditioning is effectively offline to control and monitoring requests.		

System Object	Settings		Description
System Forced Off (Setup)			Writeable object to enable and disable the global on/off command.
System Forced Off (State)			Readable object giving indication of the global on/off command.
G50 Comms State	AG-150A not responding	0	Provides an indication of the communication status between the Procon MelcoBEMS and the AG-150A.
	AG-150A comms OK	1	
Note	'AG-150A not responding' either means the AG-150A is switched off or is not connected to the network.		
New Setting Compare	Write Always	Inactive	Selects the way in which the Procon MelcoBEMS handles new command settings.
	Write COV	Active	
Note	Useful for systems which continuously write to the command parameters.		

9. Energy Monitoring with Modbus and BACnet

9.1. Overview

When the MelcoBEMS is connected to the EB50, the EB50 air conditioning energy monitoring data can be seen on the Modbus or BACnet BEMS network.

It is important to activate the AG-150 Energy PIN code on the EB50 to allow energy monitoring. At least one PAC-YG60MCA must be connected to the EB50 to allow the EB50 to monitor pulses from the field supplied energy meter.

The BEMS will be able to monitor two different points:

- Previous Day Energy (kWh)
- Previous Month Energy (kWh)

The MelcoBEMS does not log the air conditioning energy data. It is down to BEMS to monitor and log the data every day or every month.

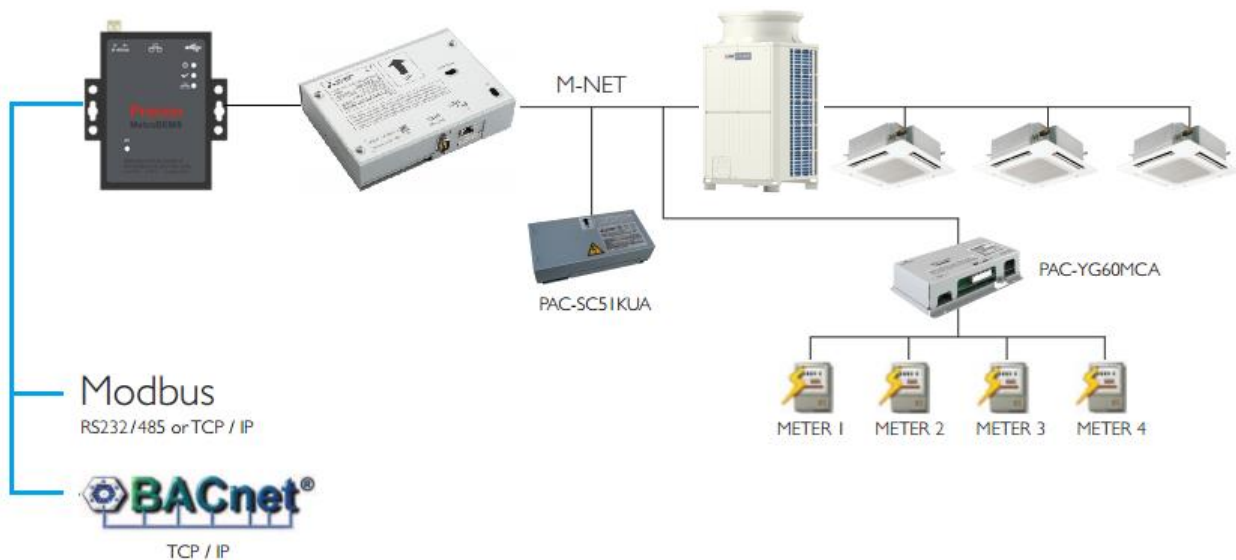

9.2. Important note about Energy monitoring

The energy monitoring data is calculated by the EB50.

The MelcoBEMS requests daily data every day at 01:05 for the previous day and monthly data at 01:15 on the first day of the month for the previous month. This is written to the BACnet TrendLog at 01:30. Monthly and daily data are also requested on power up.

We would recommend to check the values read from the BEMS with the EB50 values. To access the EB50 values, go to <http://192.168.1.1/en/administrator.html> and select Energy Management and Ranking.

Select the display range to Addresses and the timeline:

- Day if the energy is monitored daily
- Month if the energy is monitored monthly

The date must be selected to compare to the BEMS values.

For more information about air conditioning energy monitoring, refer to the EB50 manuals.

Finally select Electric Energy and refresh screen to display the graph below:

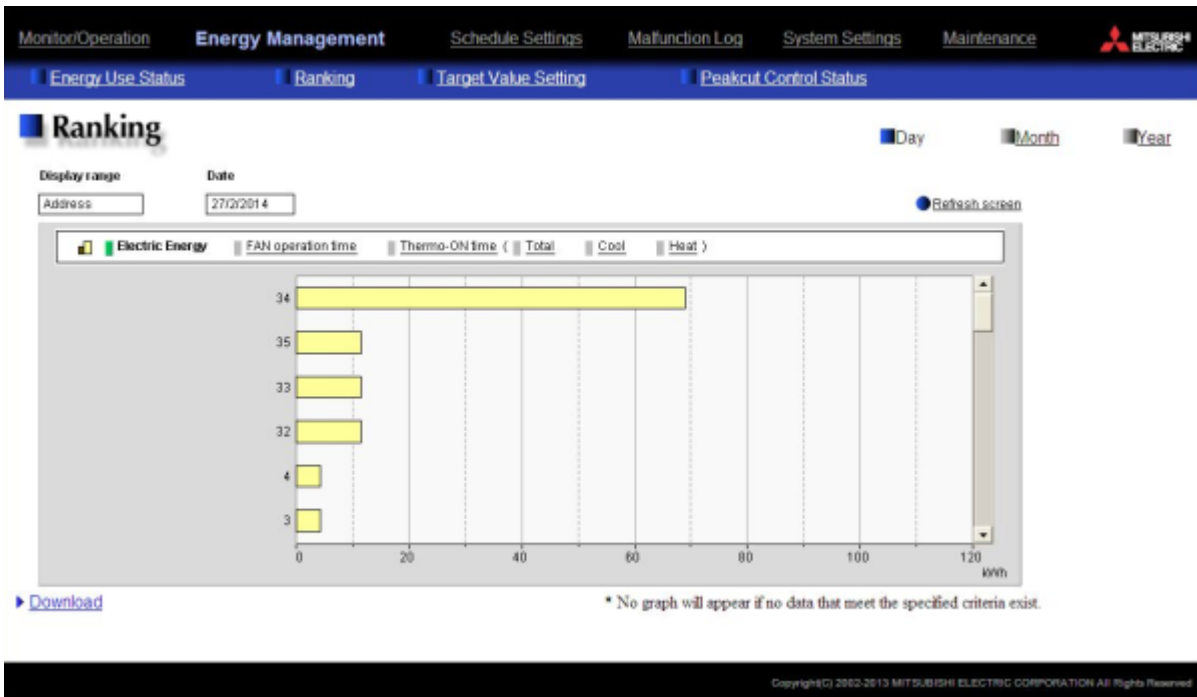

9.3. Collecting information

9.3.1. Daily monitoring

To report daily figures, the BEMS must download the energy monitoring information for each unit every day.

9.3.2. Monthly monitoring

To report daily figures, the BEMS must download the energy monitoring information for each unit every month.

10. Applicable Models

Below is a list of models that can be connected to this unit using a centralised controllers:

- M Series product range with a MAC-333IF per indoor unit
- Mr Slim product range with a PAC-SF83MA or PAC-SJ18MA per outdoor unit
- City Multi product range
- CAHV unit
- PWFY unit
- Air curtain
- AHU interfaces
- Lossnay RX5 models

11. Important Notes

- The Modbus network must be connected A to A, B to B, GND to GND
- Screened cable must be used on the Modbus network
- The Modbus network must be daisy chained and not in a star network
- The following PIN codes must be set:
 - o EB50: AG-150-Basic
 - o AG150: AG-150-Basic
- The centralised controller groups must be set properly i.e. the lowest MNET address within the group **must** match the group number
- The Procon MelcoBEMS IP address is 192.168.1.11
- When using EB50 energy monitoring, the AG-150-Energy PIN code is required and at least one energy meter must be supplied by others
- The air conditioning energy monitoring data is only available with the EB50 and therefore not available with the AG150 or the GB50-ADA
- Modbus TCP supports up to 3 simultaneous connections
- The serial port has no concept of TCP connections
 - o RS232 is Point To Point. So only 2 devices are possible. A single modbus master and MelcoBEMS.
 - o RS485 is MultiPoint design. Normally up to 32 devices on the Modbus RS 485 network are possible.(There are exceptions-it can be more). Only a single modbus master on the modbus network is allowed.
- MelcoBEMS is always a slave. This is true for Modbus TCP/RS232/RS485
- The energy monitoring data is calculated by the EB50. The MelcoBEMS requests daily data every day at 01:05 for the previous day and monthly data at 01:15 on the first day of the month for the previous month. This is written to the BACnet TrendLog at 01:30. Monthly and daily data are also requested on power up
- It is important to set the time properly on the centralised controller as the MelcoBEMS synchronises the time from the centralised controller
- Only the groups set on the centralised controller will be shown on the BACnet objects
- The dual setpoint function is currently not available with the MelcoBEMS
- **The group number, the location and the MNET (indoor unit) addresses may not always match. For instance, indoor unit address 01 may be allocated to group 01 but the location on the centralised controller may say Area 20. 20 is not the group number you should be talking to.**

We do recommend that the Air Conditioning contractor supplies a schedule as below:

Group Number	MNET Indoor Unit Address	Location / Controller Name
01	01, 02	Room A
02		
03	03	Room B
04	04	Room C
...	...	

12. Declaration of Conformity

EC- DECLARATION OF CONFORMITY 

For the following equipment :

Equipment: Mitsubishi Electric Interface Platform

Model Name: MelcoBEMS

Applicant: Synapsys Solutions Ltd.

Address: No. 1 Woodlands Court, Albert Drive, Burgess Hill, West Sussex, RH15 9TN, UK

Is herewith confirmed to comply with the requirements set out in the Council Directive on the Approximation of the Laws of the Member States relating to Electromagnetic Compatibility (2004/108/EC). For the evaluation regarding the electromagnetic compatibility, the following standards were applied :

EN55022 CLASS A: 2006+A1:2007	IEC 61000-4-2 : 2001
EN 61000-3-2:2006	IEC 61000-4-3 : 2008
EN 61000-3-3:1995+A1:2001+A2:2005	IEC 61000-4-4: 2004
EN55024:1998+A1:2001+A2:2003	IEC 61000-4-5: 2005
	IEC 61000-4-6: 2008
	IEC 61000-4-8: 2001
	IEC 61000-4-11: 2004

The following manufacturer/importer is responsible for this declaration :

Person responsible for marking this declaration :

HARVEY ROFT-IND. 19th Feb 16 

(Place) (Date) (Signature)

This product is designed and intended for use in the residential, commercial and light-industrial environment.

The product at hand is based on the following EU regulations:

- Low Voltage Directive 73/23/EEC
- Electromagnetic Compatibility Directive 89/336/EEC

Please be sure to put the contact address/telephone number on this manual before handing it to the customer.

mitsubishi electric uk

MITSUBISHI ELECTRIC UK, TRAVELLERS LANE, HATFIELD HERTFORDSHIRE, AL10 8XB